





User's Manual

(May 2005)





TRADEMARKS

All brand and product names are trademarks or registered trademarks of their respective companies.

NOTE

The information in this manual is subject to change without notice.



Table of Contents

Preface.....	5
Table of Contents.....	i
Preface	v
Notational Conventions.....	vi
Getting Started.....	1
Getting the Computer Running.....	2
Unpacking.....	2
Connecting to AC Power.....	2
Opening the Cover.....	3
Turning On and Off the Computer.....	4
Taking a Look at the Computer.....	6
Right-Side Components.....	6
Left-Side Components.....	7
Rear Components.....	8
Bottom Components.....	9
Top-open Components.....	10
Where to Go from Here.....	13
Operating Your Computer.....	1
Starting and Stopping the Computer.....	2
Starting the Computer.....	2
Stopping the Computer.....	2
Using the Keyboard.....	4
Typewriter Keys.....	4

Cursor-Control Keys.....	5
Numeric Keypad.....	6
Function Keys.....	7
Fn Key.....	8
Hot Keys.....	8
Using the Touchpad.....	10
Configuring the Touchpad.....	12
Using the Hard Disk Drive.....	13
Using the DVD Drive.....	14
Inserting and Removing a Disc.....	15
Using the Video Features.....	17
Configuring the Display Modes.....	17
Using the Audio Features.....	18
Connecting Audio Devices.....	19
Using the Communication Features.....	20
Using the Modem.....	20
Using the LAN.....	21
Using the Wireless LAN (option).....	21
Managing Power.....	1
AC Adapter.....	2
Battery Pack.....	3
Charging the Battery Pack.....	3
Initializing the Battery Pack.....	4
Checking the Battery Level.....	4
Replacing the Battery Pack.....	5
Battery Low Signals and Actions.....	6
Power Management.....	8
Hibernation.....	9
Power-Saving Tips.....	10
Expanding Your Computer.....	1
Connecting an External Display.....	2
Connecting a TV.....	4
Connecting a USB Device.....	5

Connecting an IEEE 1394a Device.....	6
Using PC Cards.....	7
PC Card Type.....	7
CardBus Support.....	7
Inserting and Removing a PC Card.....	7
Using the Card Reader.....	9
Internal Components Upgrade.....	11
Using BIOS Setup.....	1
When and How to Use BIOS Setup.....	2
When to Use.....	2
Starting BIOS Setup.....	2
Moving Around and Making Selections.....	3
Main Menu.....	4
Security Menu.....	5
Boot Menu.....	6
Exit Menu.....	7
Installing Software Drivers.....	1
How to Use the Driver CD.....	2
Using the OSD.....	5
Caring for the Computer.....	1
Protecting the Computer.....	2
Using the Password.....	2
Using the Cable Lock.....	2
Using an Anti-Virus Strategy.....	3
Taking Care of the Computer.....	4
Location Guidelines.....	4
General Guidelines.....	4
Cleaning Guidelines.....	5
Battery Pack Guidelines.....	5
When Traveling.....	6
Troubleshooting.....	1
Preliminary Checklist.....	2

Solving Common Problems.....	3
Battery Problems.....	4
DVD Drive Problems.....	4
Display Problems.....	5
Hardware Device Problems.....	8
Hard Disk Drive Problems.....	8
Keyboard, Mouse, and Touchpad Problems.....	8
LAN Problems.....	9
WLAN Problems.....	9
Modem Problems.....	11
PC Card Problems.....	11
Power Management Problems.....	12
Software Problems.....	12
Sound Problems.....	13
Startup Problems.....	14
Other Problems.....	14
Resetting the Computer.....	15
Specifications.....	1
Regulatory Information.....	1
On the Use of the System.....	2
Class B Regulations.....	2
Safety Notices.....	3
On the Use of RF Device.....	6
USA and Canada Safety Requirements and Notices.....	6
European Union CE Marking and Compliance Notices.....	10
Index	1

Preface

This manual contains information that will help you operate the computer. It is divided into 8 chapters, 2 appendices, and an index.

- Chapter 1, **Getting Started**, takes you through the process of setting up the computer and identifying its external components.
- Chapter 2, **Operating Your Computer**, tells you how to use the computer's components and features.
- Chapter 3, **Managing Power**, provides information on power.
- Chapter 4, **Expanding Your Computer**, provides information on installing and using peripheral devices.
- Chapter 5, **Using BIOS Setup**, describes the SCU program that configures the computer's BIOS settings.
- Chapter 6, **Installing Software Drivers**, describes how to install the drivers and utilities supplied with the computer.
- Chapter 7, **Caring for the Computer**, gives you tips in care and maintenance.
- Chapter 8, **Troubleshooting**, gives solutions to common problems you may encounter when using the computer.
- Appendix A, **Specifications**, gives a brief specification of the computer.
- Appendix B, **Regulatory Information**, provides regulatory statements and safety notices on your computer.

Notational Conventions

Throughout this manual, the following conventions are used to distinguish elements of text.

NOTE: identifies additional information that requires special attention.

CAUTION: identifies important information that, if not followed, may result in loss of data or damage to the computer.

Keyboard keys are shown in a bold typeset. For example:

Press **Enter** to complete.

When keys are joined by a plus sign (+), press the first key, and, while keeping the first key down, press the remaining keys, finally release all the keys. When necessary, keys are also shown in graphics.

A title, command, setup item, or button that you can see on the screen is shown in boldface. A value or an option that you can select for a setup item is shown in italic. For example:

Select **Power Schemes**, set it to *Portable/Laptop*, and then click the **OK** button.

Getting Started

Congratulations on purchasing this computer.

Your computer incorporates desktop computer capabilities into a compact notebook-sized package. It can greatly enhance your productivity either in the office or at home. And, of course, wherever you need it, the computer is ready and easy “to go.”

This chapter first tells you step by step how to get the computer up and running. You will find instructions for these procedures:

- Unpacking
- Connecting to AC power
- Opening the cover
- Turning on the computer
- Turning off the computer

Then, you will find a section briefly introducing the external components of the computer. And the last section navigates you to the information you may need after the computer is ready for use.

Getting the Computer Running

This section guides you through the procedures for getting the computer ready for operation.

Unpacking

After unpacking the shipping carton, you should find these standard items:

- Notebook computer
- Accessories:
 - AC adapter
 - AC power cord
 - Driver CD
 - Ferrite core(s) – option

Inspect all the items. If any item is damaged or missing, notify your dealer immediately.

Keep the shipping carton and packing materials in case you need to ship or store the computer in the future.

Connecting to AC Power

The computer operates either on the external AC power or internal battery power.

CAUTION:

- Use only the AC adapter included with your computer. Using other AC adapters may damage the computer.
- Before using your computer with the battery pack installed for the first time, it is highly recommended that you initialize the battery pack. For information on initializing the battery pack, see Chapter 3.

1. Make sure that the computer is turned off.

2. Plug the DC cord of the AC adapter to the power connector on the rear of the computer (❶).
3. Plug the female end of the AC power cord to the AC adapter and the male end to an electrical outlet (❷).

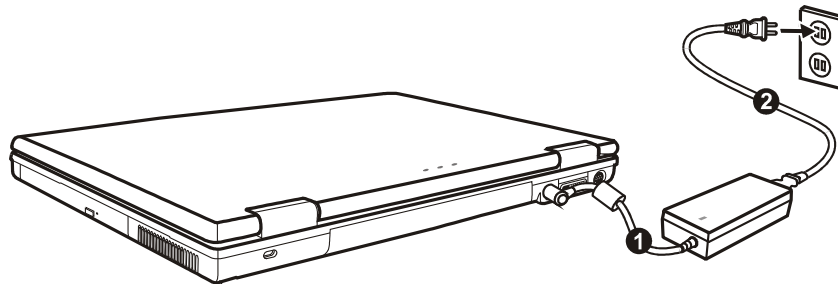

4. When the AC adapter is connected, power is being supplied from the electrical outlet to the AC adapter and onto your computer.

CAUTION:

- When you disconnect the AC adapter, disconnect from the electrical outlet first and then from the computer. A reverse procedure may damage the AC adapter or the computer.
- When unplugging the connector, always hold the plug head. Never pull on the cord.

NOTE: When the AC adapter is connected, it also charges the battery pack. For information on using battery power, see Chapter 3.

Opening the Cover

CAUTION: Be gentle when opening and closing the cover. Opening it vigorously or slamming it shut could damage the computer.

Open the top cover by sliding the cover latch toward the right (❶) and lifting up the cover (❷). You can tilt the cover forward or backward for optimal viewing clarity.

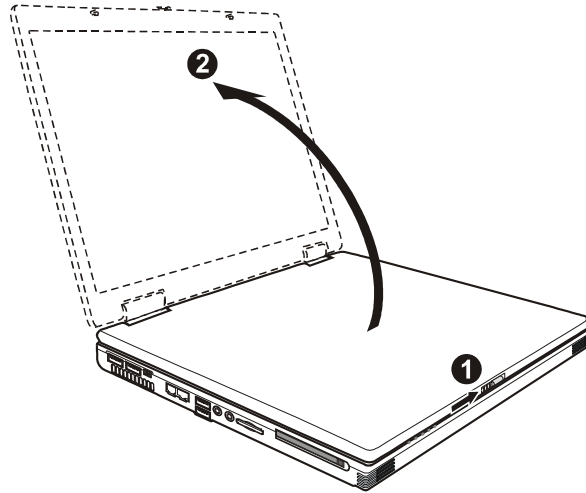

Turning On and Off the Computer

Turning On

1. Make sure that the computer is connected to AC power.
2. Press the power button.

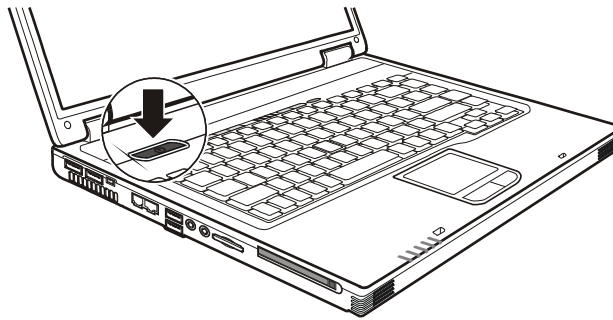

3. Each time the computer is turned on, it performs a Power-On Self Test (POST), and the operating system such as Windows should start.

Turning Off

To turn off the computer power, use the “Shut Down” command of your operating system.

NOTE: There are other ways you can stop the computer so that you will be back to where you left off when you next turn on the computer. (See “Stopping the Computer” in Chapter 2 for information.)

CAUTION: If you have to turn the computer on again immediately after turning it off, wait for at least five seconds. Turning the computer off and on rapidly can damage it.

Taking a Look at the Computer

This section identifies the external components of the computer and briefly describes the function of each component.

NOTE: Depending on the model you purchased, the appearance of your computer may not be exactly the same as those shown in this manual.

Right-Side Components

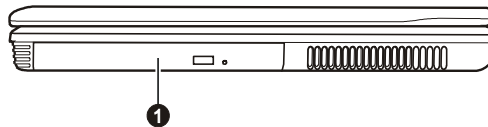

Ref	Component	Description	See Also
1	Combo/ DVD +RW/ DVD -RW/ DVD Dual/ Super Multi Drive	Accepts a compact disc for installing or loading software, accessing data, and playing music/video.	P. 14

Left-Side Components

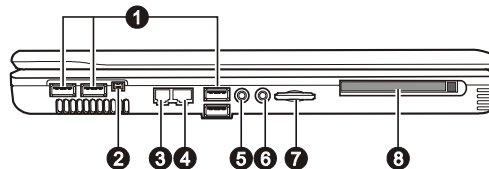

Ref	Component	Description	See Also
①	USB Ports	Each of the four ports connects a USB device, such as a USB disk, floppy disk drive, printer, digital camera, joystick, and more.	P. 4
②	Mini IEEE 1394a Port	Connects a 1394 device such as a scanner, printer, DVCAM, VCR, and more.	P. 6
③	RJ-11 Connector	Connects the telephone line.	P. 20
④	RJ-45 Connector	Connects the LAN cable.	P. 21
⑤	Microphone Connector 	Connects an external microphone.	P. 18
⑥	S/PDIF Connector	Connects a S/PDIF device such as a digital speaker set for digital audio output.	P. 19
⑦	Card Reader	Accepts a MultiMediaCard (MMC), Secure Digital (SD), or Memory Stick (MS) card for removable storage media.	P. 9
⑧	PC Card Slot	Accepts a PC card for additional functions.	P. 6

Rear Components

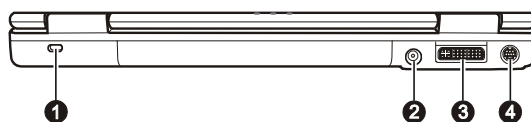

Ref	Component	Description	See Also
①	Kensington Lock	Locks the computer to a stationery object for security.	P. 2
②	Power Connector	Connects the AC adapter.	P. 2
③	DVI-I Connector	Connects an external LCD monitor or digital CRT monitor.	P. 2
④	S-video Connector	Connects an external video device, such as a TV, supporting S-video input.	P. 4

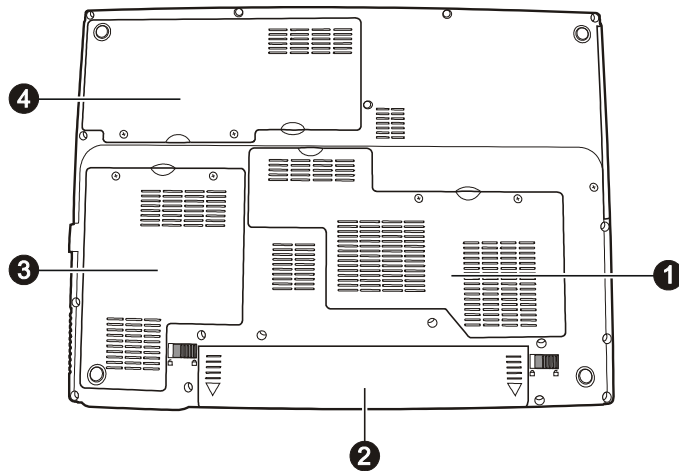

Bottom Components





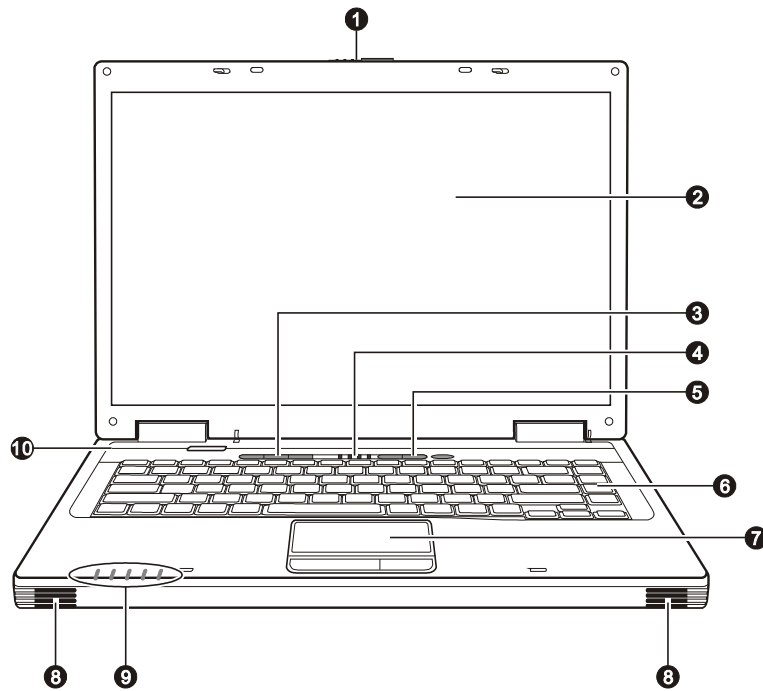









Ref	Component	Description	See Also
①	Components Cover	Inside are: Memory slot for expanding the memory size of your computer. CPU of your computer.	P. 11
②	Battery Pack	Supplies power to your computer when external power is not connected.	P. 3
③	Graphic Card Compartment	Inside is the graphic card of your computer.	
④	Components Cover	Inside are: Mini PCI slot for using an optional Mini PCI card. Depending on your model, an internal Mini PCI wireless LAN card may have been pre-installed. Hard disk drive of your computer.	P. 21 P. 13

Top-open Components



Ref	Component	Description	See Also
①	Top Cover Latch	Locks the top cover.	P. 3
②	LCD Screen	Displays the output of the computer.	P. 17
③	Quick Launch Keys		
		 Turns the WLAN radio on and off.	
		 Internet Explorer quick start key.	
		 Microsoft Outlook quick start key.	

Ref	Component	Description	See Also
④	Device Indicators	Show the current status of the computer's devices.	
		Power Indicator Glows green when the computer is turned ON. Blinks green when the computer is in Standby mode.	P. 3-2, 3-6
		Battery Charge Indicator Glows green when the battery is fully charged and connected to AC power. Glows amber when the battery is being charged. Blinks red when the battery is almost completely discharged.	P. 3
		Wireless LAN indicator	P. 22
		Card Reader indicator	P. 9
⑤	Volume Control Keys		P. 18
		Decreases the sound volume	
		Increases the sound volume	
		Switches system sound output off (mute) and on	
⑥	Keyboard	Serves as the data input device of the computer.	P. 4
⑦	Touchpad	Serves as the pointing device of the computer. It consists of a rectangular pad as well as left and right buttons.	P. 7
⑧	Stereo Speaker Set	Sends out sound and voice from the computer.	P. 18

Ref	Component	Description	See Also
9	Device Indicators	Show the current status of the computer's devices.	
		DVD drive in-use indicator	P. 15
		Hard disk drive in-use indicator	P. 13
		Num Lock indicator	P. 4
		Caps Lock indicator	P. 5
		Scroll Lock indicator	P. 5
10	Power Button	Turns the computer power ON and OFF.	P. 4

Where to Go from Here

As your computer is ready for operation, you may want to do any of the following now:

For this purpose...	Do this...
To know more about the computer...	Go on to the next chapter.
To install the operating system if your dealer has not already done so...	See the operating system manual.
To know more about the operating system...	Read the operating system manual.
To install the drivers if your dealer has not already done so...	See Chapter 6.
To set a power-on password...	See “Security Menu” in Chapter 5.
To charge the battery pack for the first time...	See “Charging the Battery Pack” in Chapter 3.

Operating Your Computer

This chapter provides information about the use of the computer.

If you are new to computers, reading this chapter will help you learn the operating basics. If you are already a computer user but are new to notebook computers, you may choose to read only the parts containing information unique to your computer.

Described in this chapter are the operating basics of these components:

- Keyboard
- Touchpad
- Hard disk drive
- DVD drive

And these features:

- Starting and stopping the computer
- Video features
- Audio features
- Communication features

Starting and Stopping the Computer

There are a number of ways to start and stop the computer.

Starting the Computer

You always start the computer using the power button.

A computer starts up with an operating system (OS) existing on the storage device such as the hard disk. The computer will automatically load the OS after you turn it on. This process is called booting.

NOTE: An operating system is the platform for all your software application programs to run on. The most widely used operating system today is Microsoft Windows.

Stopping the Computer

When you finish a working session, you can stop the computer by turning off the power or leaving the computer in Standby or Hibernation mode:

To stop in this mode...	Do this...	To start up or resume again
Off	<p>Follow the shutdown procedure of your operating system. This can prevent loss of unsaved data or damage to your software programs.</p> <p>If the system is locked up because of hardware or software problems, press the power button to turn off the computer.</p>	Press the power button.
Standby	<p>Depending on your settings in Windows, you can place the computer in Standby mode by:</p> <ul style="list-style-type: none"> • Closing the display cover • Pressing Fn+F12 • Pressing the power button 	Press any key.

To stop in this mode...	Do this...	To start up or resume again
Hibernation	<p>Depending on your settings in Windows, you can place the computer in Hibernation mode by:</p> <ul style="list-style-type: none"> • Closing the display cover • Pressing Fn+F12 • Pressing the power button 	Press the power button.

If you choose to stop in Standby or Hibernation mode, you can return to where you left off the next time you start up the computer. (See “Power Management” in Chapter 3 for more information.)

Using the Keyboard

Your keyboard has all the standard functions of a full-sized computer keyboard plus a **Fn** key added for specific functions.







The standard functions of the keyboard can be further divided into four major categories:





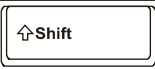

- Typewriter keys
- Cursor-control keys
- Numeric keys
- Function keys

Typewriter Keys

Typewriter keys are similar to the keys on a typewriter. Several keys are added, such as the **Ctrl**, **Alt**, **Esc** and lock keys, for special purposes.

When the lock keys are pressed, their corresponding indicators light up.

Key	Description
	The Control key is normally used in combination with other keys for program-specific functions.
	The Alternate key is normally used in combination with other keys for program-specific functions.
	The Escape key is usually used for stopping a process. Examples are exiting a program and canceling a command. The function depends on the program you are using.
	The Shift key is used with alphabet letter keys to produce uppercase letters when typing. It is also used in combination with other keys for program-specific functions.
	The Backspace key moves the cursor left one space and deletes the character in that space.
	Pressing Fn and this key toggles the Num Lock on and off. When on ( light on), the Num Lock activates the numeric keys.





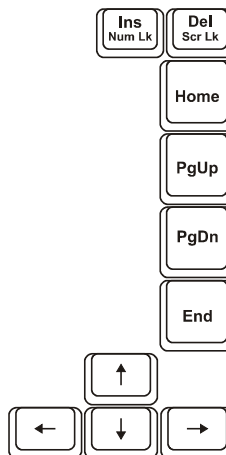





Key	Description
	Pressing Fn and this key toggles Scroll Lock on and off. When on ( light on), the screen moves one line up or down when you press ↑ or ↓ arrow key. Scroll Lock does not work for all programs.
	Pressing this key toggles the Caps Lock on and off. When on ( light on), the Caps Lock keeps the letter keys in uppercase.
	The Pause key temporarily stops screen scrolling. Scroll Lock does not work for all programs.
	The Print Screen key prints the displayed screen. Print screen does not work for all programs.

Cursor-Control Keys



NOTE: The word “cursor” refers to the indicator on the screen that lets you know exactly where on your screen anything you type will appear. It can take the form of a vertical or horizontal line, a block, or one of many other shapes.

Cursor-control keys are generally used for editing purposes. They are:

Key	Description
	Moves the cursor left one space.
	Moves the cursor right one space.
	Moves the cursor up one line.
	Moves the cursor down one line.
	Moves the page up.
	Moves the page down.
	Moves the cursor to the beginning of the line or document.
	Moves the cursor to the end of the line or document.
	Switches typing between insert and overwrite modes. Insert mode means any character typed will be inserted to the current cursor position; overwrite mode means any character typed will overwrite the text in the current cursor position.
	Deletes the character to the right of the cursor and moves the following text left one space.

Numeric Keypad

A 15-key numeric keypad is embedded in the typewriter keys as shown next:

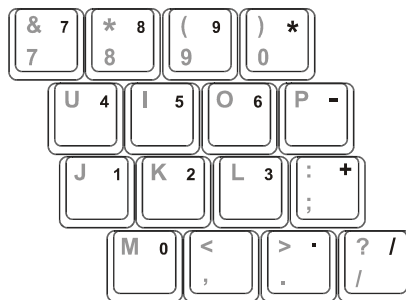

Numeric keys facilitate entering of numbers and calculations. When Num Lock is on, the numeric keys are activated, which means you can use these keys to enter numerals.

NOTES:



- When the numeric keypad is activated and you need to type the English letter in the keypad area, you can either turn Num Lock off or you can press **Fn** and then the letter without turning Num Lock off.
- Some software may not be able to use the numeric keypad on the computer. If so, use the numeric keypad on an external keyboard instead.



Euro Symbol

You can press the euro dollar sign € on various keyboards.

- To press the euro sign on a United States-International keyboard, hold down the **Alt Gr** key and press **5** (which has an euro sign on it).
- To press the euro sign on a standard United States keyboard, hold down either of the **Alt** keys and type **0128** on the numeric keypad part of your keyboard.
- To press the euro sign on an UK keyboard, hold down the **Alt Gr** key and press **4** (which has an euro sign on it).

Windows Keys

The keyboard has two keys that perform Windows-specific functions:  Windows Logo key and  Application key.

The  Windows Logo key opens the Start menu and performs software-specific functions when used in combination with other keys. The  Application key usually has the same effect as a right mouse click. (See your Windows manual for more information.)

Function Keys

On the top row of the keys are the function keys: **F1** to **F12**. Function keys are multi-purpose keys that perform functions defined by individual programs.

Hot key functions are assigned to **F1**, **F3**, **F4**, **F5**, **F6**, **F7**, **F10**, **F11**, and **F12** by your computer. (See “Hot Keys” later in this chapter for information.)







Fn Key













The **Fn** key, at the lower left corner of the keyboard, is used with another key to perform the alternative function of a key. The letter “Fn” and the alternative functions are identified by the color of blue on the keytop. To perform a desired function, first press and hold **Fn**, then press the other key.

Hot Keys

Hot keys refer to a combination of keys that can be pressed any time to activate special functions of the computer. Most hot keys operate in a cyclic way. Each time a hot key combination is pressed, it shifts the corresponding function to the other or next choice.

You can easily identify the hot keys with the icons imprinted on the keytop. The hot keys are described next.

Key	Description
 	Switches the wireless LAN radio on and off. NOTES: <ul style="list-style-type: none">• This function works only if an optional Mini PCI wireless LAN card is installed.• The FAA (Federal Aviation Agency) has deemed it unsafe to operate wireless devices in aircraft as this may interfere with flight safety. Remember to turn off wireless LAN when using your computer in the airplane.
 	Decreases the sound volume.
 	Increases the sound volume.

Key	Description
 	<p>Switches the display output to one of the following when an external device is connected.</p> <p>Upon booting the system with CRT:</p>  <p>NOTES:</p> <ul style="list-style-type: none"> • When playing DVD or MPEG file, display switching is not allowed. • This function only applies to Plug & Play CRT monitors.
 	Decreases the LCD brightness.
 	Increases the LCD brightness.
 	Switches Battery Low beep on and off.
 	Switches the display on and off.
 	Serves as the sleep button that you can define with Windows' Power Options . (See the "Power Management" in Chapter 3.)

Using the Touchpad

CAUTION: Do not use a sharp object such as a pen on the touchpad. Doing so may damage the touchpad surface.

NOTE: For optimal performance of the touchpad, keep your fingers and the pads clean and dry. When tapping on the pad, tap lightly. Do not use excessive force.

The touchpad is a pointing device that allows you to communicate with the computer by controlling the location of the pointer on the screen and making selection with the buttons.

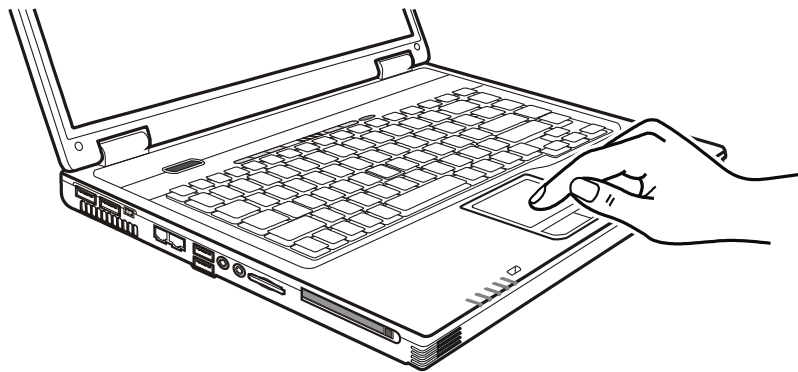

The touchpad consists of a rectangular pad, as well as a left and right button. To use the touchpad, place your forefinger or thumb on the pad. The rectangular pad acts like a miniature duplicate of your display. As you slide your fingertip across the pad, the pointer (also called cursor) on the screen moves accordingly. When your finger reaches the edge of the pad, simply relocate yourself by lifting the finger and placing it on the other side of the pad.

Here are some common terms that you should know when using the touchpad:

Term	Action
Point	Move your finger on the pad until the cursor points to the selection on the screen.
Click	Press and release the left button. –or– Tap gently anywhere on the pad.
Double-click	Press and release the left button twice in quick succession. –or– Tap twice on the pad rapidly.
Drag and drop	Press and hold the left button, then move your finger until you reach your destination (drag). Finally, release the button (drop) when you finish dragging your selection to the destination. The object will drop into the new location. –or– Gently tap twice on the pad and on the second tap, keep your finger in contact with the pad. Then, move your finger across the pad to drag the selected object to your destination. When you lift your finger from the pad, the selected object will drop into place.
Scroll	To scroll is to move up and down or left and right in the working area on the screen. This function works only after you install the touchpad driver supplied with the computer and it may not work for all applications.

TABLE NOTE: If you swap the left and right buttons, “tapping” on the touchpad as an alternative method of pressing the left button will no longer be valid.

Configuring the Touchpad

You may want to configure the touchpad to suit your needs. For example, if you are a left-handed user, you can swap the two buttons so that you can use the right button as the left button and vice versa. You can also change the size of the on-screen pointer, the speed of the pointer, and so on.

To configure the touchpad, you can use the standard Microsoft or IBM PS/2 driver if you are using Windows. However, you can install the touchpad driver supplied with your computer to take advantage of more powerful features.

Using the Hard Disk Drive

Your computer comes with a hard disk drive as drive C.

A hard disk drive is a storage device with non-removable, rotating, magnetic storage platters inside it. It is where your operating system and application software programs are stored.

Your hard disk drive is a 2.5-inch standard PATA (Parallel ATA) hard disk drive that supports transfer rates up to 100 MB/s. This type of drive embodies the latest in fast, reliable mass storage by integrating all the control circuitry necessary for operation directly onto the drive itself. This allows the drive manufacturer to carefully optimize drive performance.

CAUTION:

- Make regular backups of your data files from your hard disk drive to optical discs or other storage media.
- Never try to remove or install the hard disk drive while the computer is powered on. Doing so can result in loss of data, and can damage the computer and the hard disk drive's sensitive circuitry.
- Never turn off or reset the computer while the hard disk drive in-use indicator is on.

Using the DVD Drive

Your computer comes with a DVD drive, usually configured as drive D. Depending on the model, your drive is one of the following:

- **Combo drive** can work both as a DVD-ROM drive for reading DVD (Digital Versatile Disc) discs in addition to CDs, audio CDs and CD-R/-RW discs, and CD-RW drive writing to CD-R/-RW discs.
- **DVD+RW drive** besides the Combo drive function, can write to DVD+R/+RW discs.
- **DVD-RW drive** besides the Combo drive function, can write to DVD-R/-RW discs.
- **DVD Dual drive** besides the Combo drive function, can also write to DVD-R/-RW/+R/+RW discs.
- **Super Multi drive** besides the Combo drive function, can write to DVD+R/+RW/-R/-RW and DVD-RAM discs.

CAUTION:

- When inserting a disc, do not use force.
- Make sure that the disc is correctly inserted into the tray, and then close the tray.
- Do not leave the DVD tray open. Also, avoid touching the lens in the tray with your hand. If the lens becomes dirty, the DVD drive may malfunction.
- Do not wipe the lens using materials with rough surface (such as paper towel). Instead, use a cotton swab to gently wipe the lens.

FDA regulations require the following statement for all laser-based devices:

“Caution, Use of controls or adjustments or performance of procedures other than those specified herein may result in hazardous radiation exposure.”

NOTES:

- The DVD drive is classified as a Class 1 laser product. This label is located on the DVD drive.

**CLASS 1 LASER PRODUCT
LASER KLASSE 1**

- This product incorporates copyright protection technology that is protected by method claims of certain U.S. patents and other intellectual property rights owned by Macrovision Corporation and other rights owners. Use of this copyright protection technology must be authorized by Macrovision Corporation, and is intended for home and other limited viewing uses only unless otherwise authorized by Macrovision Corporation. Reverse engineering or disassembly is prohibited.

Inserting and Removing a Disc

Follow this procedure to insert or remove a disc:

1. Turn on the computer.
2. Press the eject button and the tray will slide out partially. Gently pull on it until it is fully extended.
3. To insert a disc, place down the disc in the tray with its label facing up. Slightly press the center of the tray until it clicks into place.

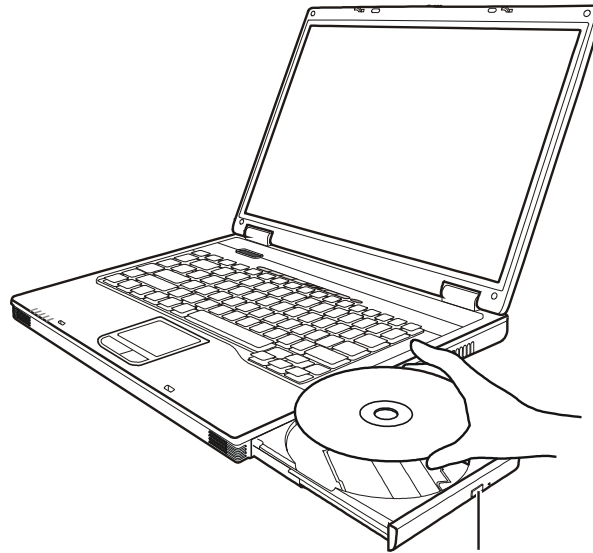

Eject Button

To remove a disc, hold the disc by its outer edge and lift it up from the tray.

4. Gently push the tray back into the drive.

NOTE: In the unlikely event that you are unable to release the tray by pressing the eject button, you can manually release the tray (see “DVD Drive Problems” in Chapter 8).

Using the Video Features

The video subsystem of your computer features:

- 15.4-inch wide TFT (Thin-Film Transistor) color LCD display with 1280×800 / 1680×1050 WXGA / WSXGA+ resolution
- Simultaneous display on LCD and external CRT monitors, which is useful when you have a presentation as you can control the screen from your computer and face the audience at the same time.
- Multi-display capability, which allows you to expand your desktop on the screen to another display device so that you have more desktop space to work on.
- Power Management.

NOTES:

- Before using the multi-display capability, the video driver supplied with your computer must be installed.
- System enters Standby/Hibernation mode when the LCD is closed. If you want to use the computer with the LCD closed, set *Do Nothing* to the “When I close the lid of my portable computer” option in the **Power Options** Properties. Thus the computer does not enter Standby or Hibernation mode when the LCD is closed.

Configuring the Display Modes

NOTES:

- To take advantage of the enhanced video capabilities, the video driver supplied with your computer must be installed.
- When using external CRT monitor only, the resolution depends on the external CRT monitor’s supported resolution.

Your computer has been set to a default resolution and number of colors before shipment. You can view and change display settings through your operating system. See your operating system documentation or online help for specific information.

For displaying in higher resolutions, you can connect an external CRT monitor that supports higher resolutions. (See “Connecting an External Display” in Chapter 4 for more information.)

Using the Audio Features

NOTES:

- To take advantage of the enhanced audio capabilities, the audio driver supplied with your computer must be installed.
- If you experience interference while recording, try lowering the microphone recording volume.

The audio subsystem of your computer features:

- Built-in sound system for recording and playing sound on your computer
- Azalia interface (2 channels)
- AC97 support
- External audio connectors (❶)
- Set of speakers (❷) and
- Volume control / mute (❸)

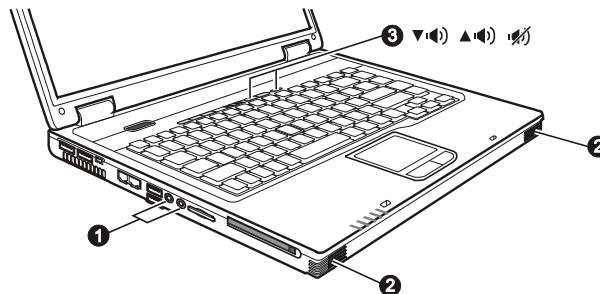

Ways of playing and recording sound vary with the operating system used. See your operating system documentation or online help for specific information.

Connecting Audio Devices

For higher audio quality, you can send or receive sound through external audio devices.

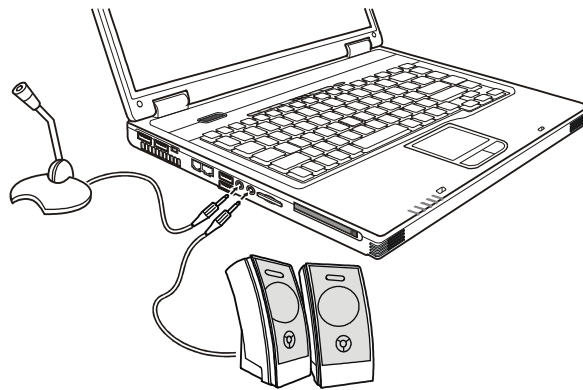

- **Microphone Connector** () can be connected to an external microphone for recording voice or sound.
- **S/PDIF Connector** (**S/PDIF**) can be connected to the line-in connector of S/PDIF (Sony/Philips Digital InterFace) compliant as well as ordinary powered speakers with built-in amplifiers, headphones, or earphone set. S/PDIF is a new audio transfer file format that ensures a high quality digital audio output through optical fibers.

NOTE: When using external speakers/headphones or microphone, you cannot use the internal one.

Using the Communication Features

Using the Modem

NOTE: To take advantage of the modem feature, the modem driver supplied with your computer must be installed.

The internal 56 K fax/data modem allows you to use the telephone line to communicate with others by fax, email, or connect to an online service or bulletin board.

To connect the telephone line to the modem, connect one end of the modem cable to the RJ-11 connector on the computer and the other end to the phone line.

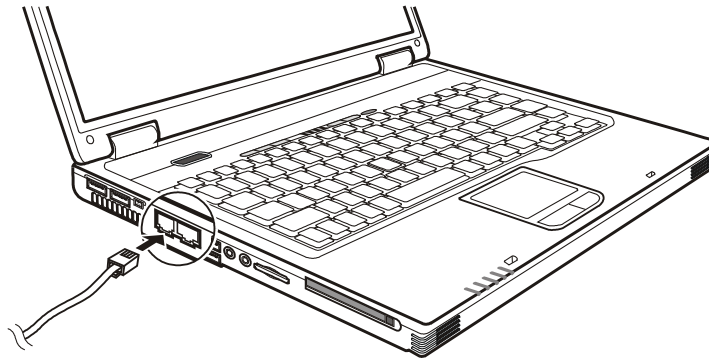

NOTES:

- When using communication software, you may have to disable power management.
- Set the COM port of the modem to COM3.
- Set parameters such as modem speed (baud rate) and line type (pulse dialing or tone dialing).
- Do not enter Standby mode when using communication software.

Using the LAN

NOTE: To take advantage of the LAN feature, the LAN driver supplied with your computer must be installed.

The internal 10/100Base-TX LAN (Local Area Network) module allows you to connect your computer to a network.

To connect the network cable to the LAN module, connect one end of the LAN cable to the RJ-45 connector on the computer and the other end to the network hub.

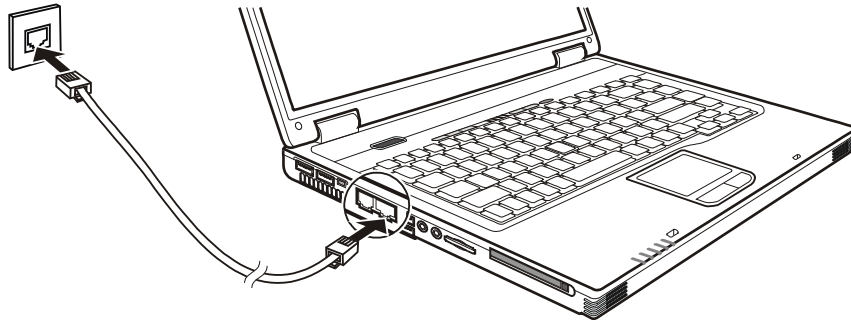

Using the Wireless LAN (option)

Depending on your model, an internal Mini PCI Wireless LAN (WLAN) card may have been pre-installed by your computer manufacturer at the factory. This card allows you to access corporate networks or the Internet in a wireless environment.

The WLAN features include:

- 2.4 GHz DSSS (Direct Sequence Spread Spectrum) technology
- Peer-to-Peer (Ad-Hoc) and Access Point (Infrastructure) modes support
- WEP (Wired Equivalent Privacy) 64/128-bit data encryption

- Transmission rate at 9 / 18 / 36 / 54 Mbps (802.11g mode), with automatic data rating at 1 / 2 / 11 Mbps (802.11b mode)

To take advantage of the WLAN feature, make sure that the WLAN driver is installed correctly. If your WLAN card was provided by your dealer instead of the computer manufacturer, contact your dealer for the correct driver to use.

Turning Off/On the WLAN Radio

NOTES:

- The FAA (Federal Aviation Agency) has deemed it unsafe to operate wireless devices in aircraft as this may interfere with flight safety. Remember to turn off wireless LAN radio when using your computer in the airplane.
- The information in this section applies to models with the wireless LAN module only.
- Turning the wireless LAN radio off is not the same as turning off the Windows WLAN utility.

Your computer has a built-in WLAN quick launch key and **Fn+F1** WLAN hot key to switch the WLAN radio on/off (see “Top-open Components” in chapter 1 and “Hot Keys” in chapter 2).

Press the quick launch key or **Fn+F1** WLAN hot key to turn on the WLAN radio. The WLAN indicator () glows to indicate that the computer is ready for WLAN connection.

To turn off the WLAN radio temporarily, press the quick launch key or **Fn+F1** WLAN hot key. The WLAN indicator () will be off.

Upon booting up your computer, the WLAN radio's setting depends on the last state when you turn off your system. If the WLAN radio was off the last time you turn off your computer, then upon booting up your system the WLAN radio stays off, and vice versa.

It takes approximately 30 seconds for your computer to make a successful WLAN connection and approximately 10 seconds to disconnect.

Connecting to a Wireless Network

1. Make sure that the WLAN indicator () is on.

2. Double-click the **Wireless Network Connection** icon  located on your Windows system tray. If any wireless network is detected, the following window appears on screen.

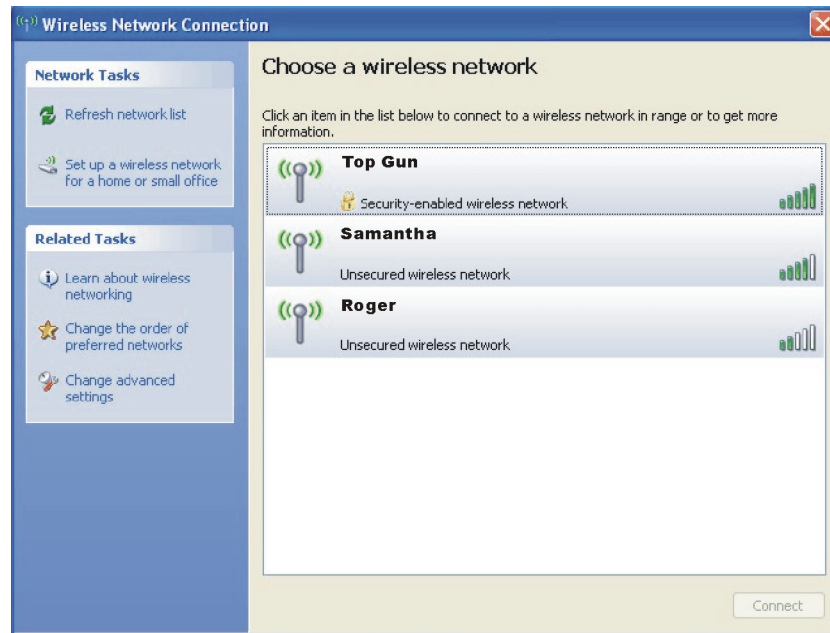

3. Select a wireless network to connect to by clicking on a selection, then click on **Connect**.
4. Depending on the settings, you may be asked to enter a WEP key (refer to your Windows online help for more information on setting a wireless network connection).

Managing Power

Your computer operates either on external AC power or on internal battery power.

This chapter tells you how you can effectively manage power. To maintain optimal battery performance, it is important that you use the battery in the proper way.

The topics in this chapter include:

- What is an AC adapter
- How to charge the battery pack
- When and how to initialize the battery pack
- How to check the battery level
- How to replace the battery pack
- What happens when the battery is low and what actions to take
- What is Power Management
- How to save power

AC Adapter

CAUTION:

- The AC adapter is designed for use with your computer only. Connecting the AC adapter to another device can damage the adapter.
- The AC power cord supplied with your computer is for use in the country where you purchased your computer. If you plan to go overseas with the computer, consult your dealer for the appropriate power cord.
- When you disconnect the AC adapter, disconnect from the electrical outlet first and then from the computer. A reverse procedure may damage the AC adapter or computer.
- When unplugging the connector, always hold the plug head. Never pull on the cord.

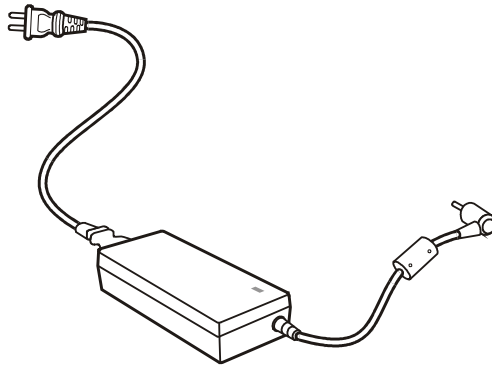

The AC adapter serves as a converter from AC (Alternating Current) to DC (Direct Current) power because your computer runs on DC power, but an electrical outlet usually provides AC power. It also charges the battery pack when connected to AC power.

The adapter operates on any voltage in the range of 100~240 V AC.

Battery Pack

The battery pack is the internal power source for the computer. It is rechargeable using the AC adapter.

The operating time of a fully charged battery pack depends on how you are using the computer. When your applications often access peripherals, you will experience a shorter operating time.

NOTE: Care and maintenance information for the battery is provided in the “Battery Pack Guidelines” section in Chapter 7.

Charging the Battery Pack

NOTES:

- Charging will not start if the battery’s temperature is below 0 °C (32 °F) or above 50 °C (122 °F).
- The charging process will stop and the Battery Charge Indicator flashes amber when the battery’s temperature gets above 60 °C (140 °F). If this happens, the battery pack may be damaged. Please contact your dealer.
- During charging, do not disconnect the AC adapter before the battery has been fully charged; otherwise you will get a prematurely charged battery.

To charge the battery pack, connect the AC adapter to the computer and an electrical outlet. The Battery Charge Indicator () on the computer glows amber to indicate that charging is in progress. You are advised to keep the computer power off while the battery is being charged. When the battery is fully charged, the Battery Charge Indicator glows green.

It takes approximately 2.5 hours to fully charge the Li-Ion battery pack when the computer is off, and approximately 4.5 hours to fully charge the Li-Ion battery pack when the computer is on.

CAUTION: After the computer has been fully recharged, do not immediately disconnect and reconnect the AC adapter to charge it again. Doing so may damage the battery.

NOTE: The battery level may automatically lessen due to the self-discharge process (0.21% per day), even when the battery pack is fully charged (100%). This happens no matter if the battery pack is installed in the computer.

Initializing the Battery Pack

You need to initialize a new battery pack before using it for the first time or when the actual operating time of a battery pack is much less than expected.



Initializing is the process of fully charging, discharging, and then charging. It can take several hours.

1. Make sure that the computer power is turned off. Connect the AC adapter to fully charge the battery pack.
2. After the battery pack is fully charged, turn on the computer. When the message “Press <F2> to enter System Configuration Utility” appears, press **F2** to invoke the program.
3. Disconnect the AC adapter and leave the computer on until the battery is fully discharged. The computer will shut down automatically.
4. Connect the AC adapter to fully charge the battery pack.

Checking the Battery Level

NOTES:

- Any battery level indication is an estimated result. The actual operating time can be different from the estimated time, depending on how you are using the computer.
- If you have not used the computer after more than a week and it is not connected to AC power, fully charge the battery in order to get an accurate reading of the battery level.

You can check the approximate battery level using the battery meter function of the operating system. To read the battery level in Windows, click the  icon on the taskbar. (Click the  icon if the computer is using AC power.)

Replacing the Battery Pack

CAUTION:

- There is danger of explosion if the battery is incorrectly replaced. Replace the battery only with the computer manufacturer's optional battery packs. Discard used batteries according to the dealer's instructions.
- Do not attempt to disassemble the battery pack.

If you often rely on battery power for a long period of time while traveling, you may consider the purchase of an additional battery pack from your dealer and keep it with you in a fully charged state as a backup.

To replace the battery pack, follow these steps:

1. Make sure that the computer is not turned on or connected to AC power.
2. Place the computer upside down.
3. Slide the battery security lock outward to the unlock (🔓) position (❶).
4. Slide the battery release lever outward to the unlock (🔓) position (❷), and, while holding it in the unlock position, remove the battery pack off the computer (❸).

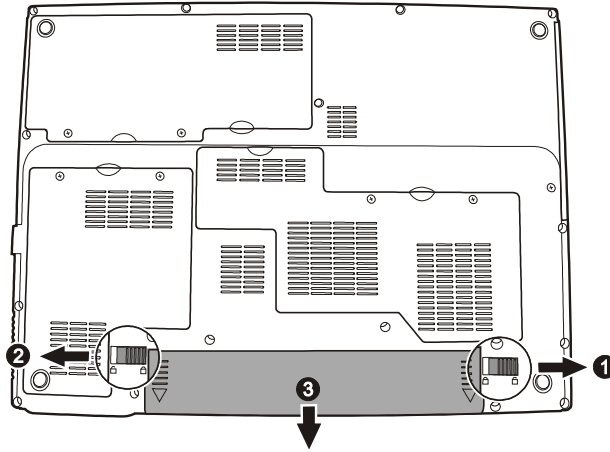

5. Fit another battery pack into place and slide the battery security lock and release lever to the lock () position.

Battery Low Signals and Actions

Battery Low occurs when the battery has approximately 10% (Windows default setting) of its charge remaining. The computer gives warning beeps or messages and the Battery Charge Indicator () blinks red to alert you to take actions.

NOTE: You can set up your threshold and signals of Battery Low under Windows.

Immediately save your data upon Battery Low. The remaining operating time depends on how you are using the computer. If you are using the audio subsystem, PC card, hard or optical drives, the battery might run out of charge very quickly.

Always respond to Battery Low by placing your computer on Standby or Hibernation mode, turning off the computer, or connecting the AC adapter.

If you do not take any action, the computer will automatically hibernate and turn off.

CAUTION:

- If you are using a flash PC card, do not access the card during battery low periods. This is because the access may take longer than the time it takes the battery to run out of charge, thus making your access to the card unsuccessful.
- If you fail to save your data when the battery completely runs out of charge, then you lose your data.

Power Management

Your computer supports ACPI (Advanced Configuration and Power Interface) for power management. The power management feature allows you to reduce the power consumption for energy saving.

With an ACPI-compliant operating system such as Windows XP, power supply to different computer components is controlled on an as-needed basis. This allows maximum power conservation and performance at the same time.

In general, Windows' power management works in this way:

What...	When...
Power to the hard disk is turned off	When the hard disk has been idle for a set period.
Power to the display is turned off	When the display has been idle for a set period.
The computer enters Standby mode. The hard disk and display are turned off and the entire system consumes less power.	When the entire system has been idle for a set period.
	When you press Fn+F12 . *
	When you close the cover. *
The computer enters Hibernation mode. (See the next subsection for more information.)	When you press Fn+F12 . *
	When you close the cover. *
	When you press the power button. *

* Depends on your settings in Windows.

For detailed information on power management, see Windows' Help.

Hibernation

NOTE: Make sure that the hibernation feature is enabled in the **Hibernate** tab of the **Power Options** Properties from the Control Panel in Windows XP.

Hibernation is a very useful feature. People frequently open many applications when they use computers. It takes some time to get all these applications open and running, and normally they all have to be closed before the system can be turned off.

When you use the hibernation feature, you do not have to close the applications. The computer stores the state of your computer to a file on the hard disk and then shut down. The next time you turn on your computer, you return to exactly where you left off.

Power-Saving Tips

In addition to your computer's automatic power management, you can do your part to maximize the battery's operating time by following these suggestions.

- Do not disable Power Management.
- Decrease the LCD brightness to the lowest comfortable level.
- If you work with an application that uses a PC card, exit the application when you finish using it.
- If you have a PC card installed, remove it when not in use. Some PC cards drain power even while they are inactive.
- Deactivate the WLAN function if you are not using it. (See "Turning Off/On the WLAN Radio" in chapter 2.)
- Turn off the computer when you are not using it.

Expanding Your Computer

You can expand the capabilities of your computer by connecting other peripheral devices. When using a device, be sure to read the instructions accompanying the device together with the relevant section in this chapter.

This chapter gives guidelines on installing and using these devices:

- External monitor
- TV
- USB device
- IEEE 1394a device
- PC card
- MMC/SD/MS card

Connecting an External Display

If you want the benefits of a larger display screen with higher resolution, you can connect an external CRT/LCD monitor to your computer.

Follow this procedure to connect an external display:

1. Make sure that the computer is not turned on.
2. Plug the CRT/LCD monitor's DVI-I-type signal connector to the computer's DVI-I port.

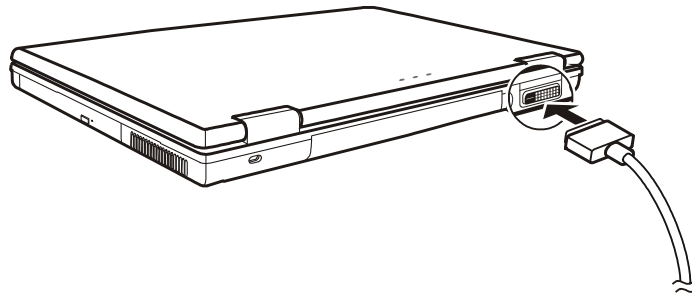

3. Plug the CRT/LCD monitor's power cord to an electrical outlet.
4. To use the CRT/LCD monitor, turn on the CRT/LCD monitor before turning on the computer.
5. The CRT/LCD monitor should respond by default. If not, you can switch the display to the CRT/LCD monitor, or to multi-display by pressing **Fn+F5**. In Windows, you can also change the display through the settings in **Display** Properties.
6. You can change display settings through your operating system. See your operating system documentation or online help for specific information.

CAUTION: Do not disconnect the external display while the computer is in Standby mode or Hibernation mode. If no external display is connected when the computer resumes, the computer's LCD might not display properly.

NOTE: You need to prepare a DVI-I to VGA adapter if connecting an analog CRT monitor.

Connecting a TV

For entertainment, conferences, or presentations, you can connect a TV to your computer.

Follow this procedure to connect a TV:

1. Make sure that the computer is not turned on.
2. Prepare an S-video cable. Plug the appropriate end of the S-video cable to the computer's S-video connector and the other end to the TV's S-video input connector.

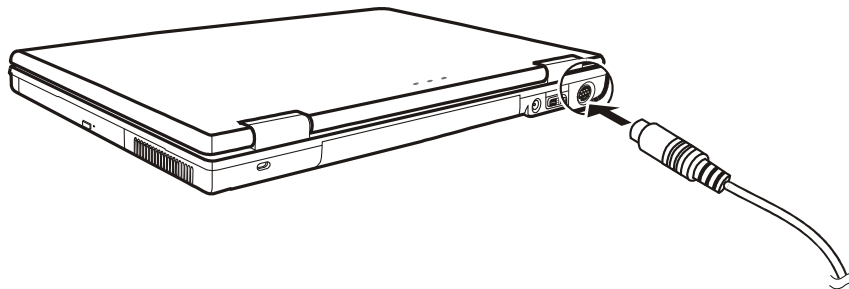

3. Since your computer cannot output sound to a TV, you can connect external speakers to the computer for better sound quality if necessary. (See “Connecting Audio Devices” in Chapter 2.)
4. Turn on the power of the TV and switch to the video mode.
5. Turn on the power of the computer and switch the display to TV by changing the display through the settings in **Display Properties** in Windows.

CAUTION:

- Do not set the display to both LCD and TV. This may cause unstable display on the LCD.
- Do not disconnect the TV while the computer is in Standby or Hibernation mode. If the TV is not connected when the computer resumes, the LCD might not display properly.
- Make sure that the VGA driver is installed correctly.

Connecting a USB Device

Your computer has four USB ports that supports transfer rates up to 12 MB/s for USB 1.1 devices and 480 MB/s for USB 2.0 devices, such as digital camera, scanner, printer, modem, and mouse.

USB is specified to be an industry standard extension to the PC architecture. It supports “Plug-and-Play” technology so you can install and remove USB devices without turning off the computer. With its multiple connection capability, up to 127 devices can be connected in a daisy-chain configuration. In addition, you can use a USB hub that converts a single USB connector into multiple ports where USB devices can be connected.

To connect a USB device, simply plug the device cable to one of the USB ports.

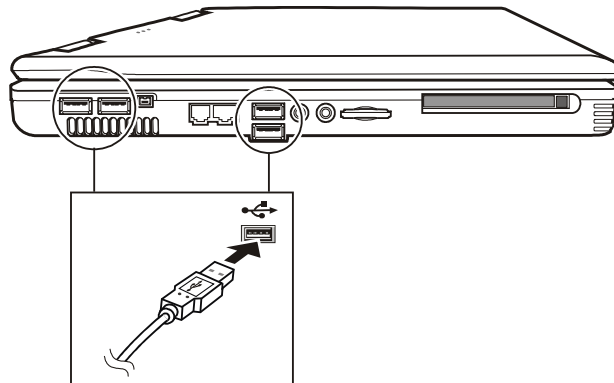

Connecting an IEEE 1394a Device

Your computer has a mini IEEE 1394a port on the computer for connecting 1394 devices.

IEEE 1394a is the next-generation serial bus standard, featuring high-speed data transfer, multi-channel communication link, and “Hot Plug” connectivity. It allows connection of up to 63 devices. The applications include not only computer peripheral devices such as scanner, printer and high-quality CCD, but also consumer electronic equipment such as DVCAM and VCR.

To connect an 1394 device, prepare an 1394 cable. Plug the appropriate end of the cable to the computer’s mini IEEE 1394a connector and the other end to the device’s corresponding connector.

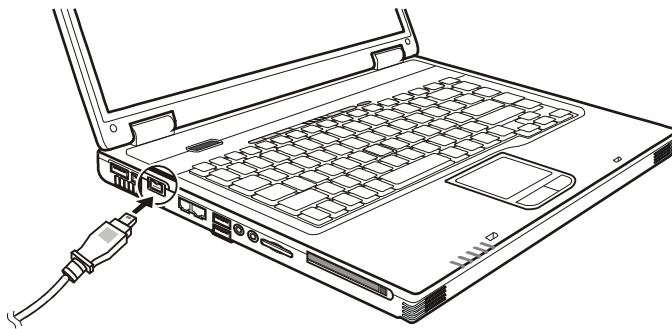

Using PC Cards

Your computer has a PC card slot.

PC cards are credit card-sized peripheral products based on the standards developed by PCMCIA (Personal Computer Memory Card International Association). PCMCIA is a non-profit association for promoting the interchangeability among mobile computers where ruggedness, low power, and small size are critical.

PC Card Type

Your computer's PC card slot can accommodate a type II card. Typical type II cards are flash memory, SRAM, modem, LAN, and SCSI cards.

CardBus Support

Your computer's PC card slot supports CardBus specifications. CardBus is the 32-bit version of PC card technology. It allows speeds of up to 133 Mbps at 33 MHz. Typical applications are SCSI host bus and high-speed network cards.

Inserting and Removing a PC Card

NOTES:

- Some PC cards require additional system resources. Before using such PC card, you may have to free other system resources for the PC card.
- Although some PC cards can be inserted and removed without turning off the computer, you cannot remove or install PC cards during Standby mode.

To insert a PC card:

1. Locate the PC card slot on the left side of the computer.
2. Slide the PC card, with its label facing up, into the slot until the eject button pops out.

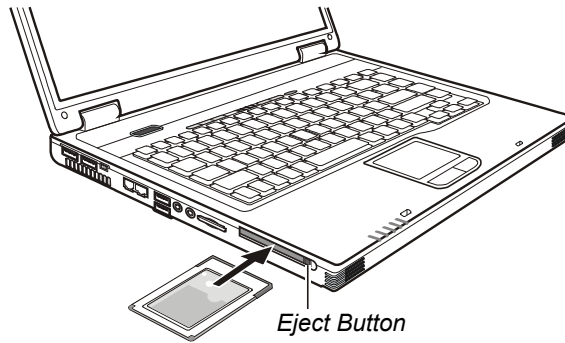

3. When a new card is seated, the computer will detect it and try to install the appropriate driver. Follow the on-screen instructions to complete the process.

To remove a PC card:

1. Double-click on the **Safely Remove Hardware**  icon found on the Windows XP taskbar and the **Safely Remove Hardware** window appears on screen.
2. Select (highlight) the PC card from the list to disable the card.
3. Push the eject button and the card will slide out slightly.
4. Pull the card out of the slot.



Using the Card Reader

NOTES:

- To take advantage of the Card Reader, the Card Reader driver supplied with your system must be installed.
- If your hard disk is divided into several drives, make sure that all drives have been formatted before using the Card Reader. Otherwise, you may encounter problems when using the Card Reader.
- You can use only storage cards. Your Card Reader does not support cards with I/O (input/output) functions such as a wireless network card or Bluetooth card.

Your computer has a Card Reader. The Card Reader is a small drive for reading from and writing to removable storage cards (or called memory cards). The cards supported are MMC (MultiMediaCard), SD (Secure Digital) and MS (Memory Stick) cards.

Shown next are the appearance and size of each card type for your reference.

Type	MMC Card	SD Card	MS Card
Appearance			
Size	24×32×1.4 (mm)	24×32×2.1 (mm)	21.5×50×2.8 (mm)

To insert a storage card:

1. Locate the Card Reader slot on the left side of the system.
2. Align the card with its connector pointing to the slot and its label facing up. Slide the card into the slot until it reaches the end. The Card Reader indicator () glows to indicate that the computer is reading the storage card.

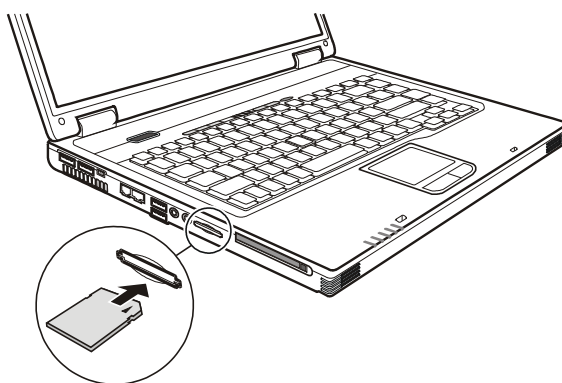

3. Windows XP will detect the card and assign it a drive name (typically E).

To remove a storage card:

1. Double-click on **My Computer**.
2. Right-click on the drive with the card and select **Eject**. The Card Reader indicator () will be off.
3. Pull the card out of the slot.

Internal Components Upgrade

You can upgrade your computer by changing the CPU or adding memory. However, to avoid damage during the installation procedure, please ask your dealer for help. Do not install an internal component by yourself.

Using BIOS Setup

System Configuration Utility (SCU) is a program for configuring the BIOS (Basic Input/Output System) settings of the computer.

BIOS is a layer of software, called firmware, that translates instructions from other layers of software into instructions that the computer hardware can understand. The BIOS settings are needed by your computer to identify the types of installed devices and establish special features.

This chapter tells you how to use the BIOS Setup.

When and How to Use BIOS Setup

When to Use

You need to run SCU when:

- You see an error message on the screen requesting you to run SCU.
- You want to restore the factory default settings.
- You want to modify some specific settings according to the hardware.
- You want to modify some specific settings to optimize system performance.

Starting BIOS Setup

NOTES:

- The SCU screens shown in this chapter are for your reference only. The actual items or settings on your computer may differ.
- The SCU program may have been updated after the publication of this manual.
- The settings you select in your operating system might override similar settings in SCU.

To run SCU, press **F2** when the prompt appears on the screen during system startup. The prompt shows up on the screen for only a few seconds. You must press **F2** quickly. The SCU main screen appears as shown next.



Moving Around and Making Selections

Use the keyboard to move around and make selections. Keyboard information can be found at the bottom of the screen. A brief description of keyboard usage is listed next:

Key	Function
← , →	Selects a menu title.
↑ , ↓	1) Selects an item or option. 2) Brings up/down the value.
Enter	Opens or closes the option window when an item is selected.
Tab	Jumps from one item to another.
Esc	1) Returns to the previous menu if in a sub-menu. 2) Closes the options window if one is open.

Main Menu

The Main menu contains the basic configuration settings of the system.

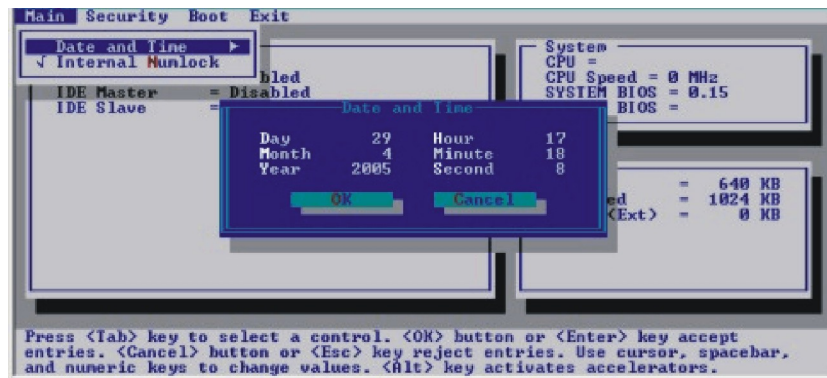

Date and Time sets the system date and time.

NOTE: If in case your CMOS battery should lose power, BIOS will reset the date to "2001/5/3".

Internal Numlock sets if you can enter a number when Num Lock is turned on. When this item is enabled and Num Lock is turned on, you can press a letter key to enter a number, and press and hold **Fn**, then a letter key to enter a letter. When this item is disabled and Num Lock is turned on, the above method works oppositely. When Num Lock is turned off, this item does not function. A check mark (✓) indicates enabled; an underline () indicates disabled. The default setting is enabled.

Security Menu

The Security menu contains the security settings, which safeguard your system against unauthorized use.



Boot Password allows you to set the password for your system. When typing the password, first make sure that **Num Lock** is off, and then type the password in the entry fields and press **Enter**. Confirm your password by typing it again and pressing **Enter**. If the **Enable Password to Power-on** sub-item is enabled, the set password is always required to boot the computer.

Boot Menu

The Boot menu sets the sequence of the devices to be searched for the operating system.

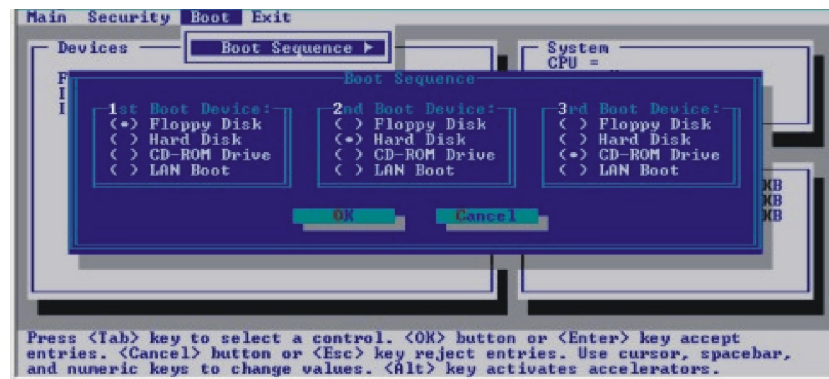

Boot Sequence sets the device to be searched for the Operating System. The system will try to boot from the first device but if it is not available, will try the next boot device. If you set the first boot device to *LAN Boot*, the system will boot from the LAN server first. The options are *Floppy Disk*, *Hard Disk*, *CD-ROM Drive*, and *LAN Boot*. The default setting is *Floppy Disk*, *Hard Disk*, then *CD-ROM Drive*.

NOTE: If you set all booting options to the same device, then the computer will try to boot from that device only.

Exit Menu

The Exit menu displays ways of exiting SCU. After finishing with your settings, you must save and exit so that the new settings can take effect.

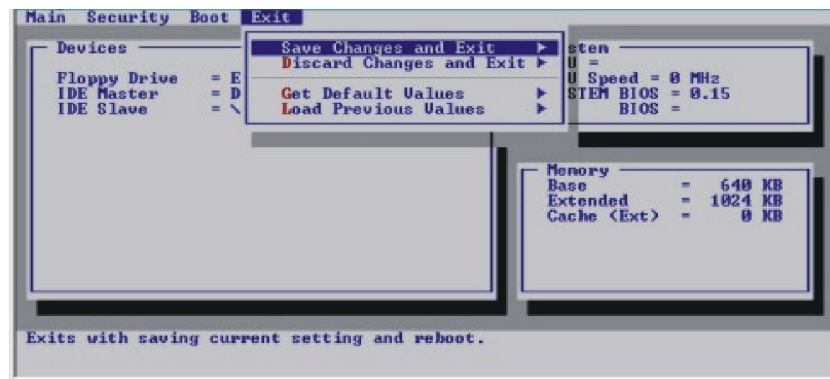

Save Changes and Exit saves the changes you have made and exits SCU.

Discard Changes and Exit exits SCU without saving the changes you have made except for changes made to the **Date and Time** item under the *Main* menu.

Get Default Values loads factory default values for all the items.

Load Previous Values loads CMOS values before running SCU.

CHAPTER **6**

Installing Software Drivers

To take full advantage of the unique features of your computer, some operating systems require custom software, known as drivers, to be installed.

If you purchased the computer with Windows pre-installed, your dealer may have already installed the drivers. If not, you need to install the drivers using the CD supplied with your computer.

This chapter describes how to install the drivers.

How to Use the Driver CD

NOTES:







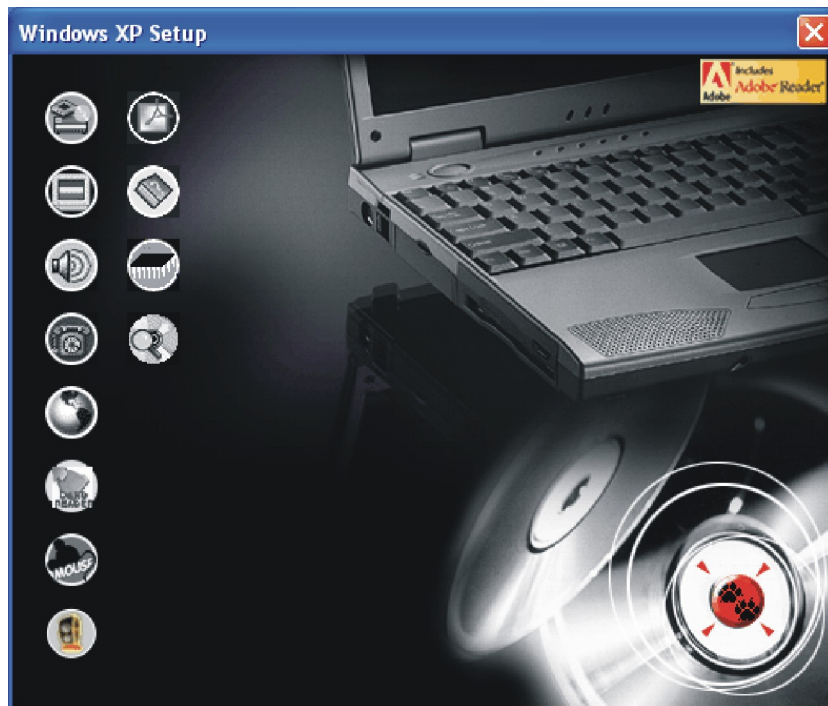



- The drivers may have been updated after this manual was published. For driver's upgrade, please contact your dealer.
- This CD supports Windows XP only. You are recommended to install Windows XP Service Pack 2.
- The available items may differ according to your computer model.
- Please do not remove the driver CD when installing the driver.



An autorun program is provided on the driver CD to help you easily install the drivers. As you insert the CD, the autorun program automatically starts. If you need to start the program manually, run the **Setup.exe** program from the **Wsetup** directory of the CD.

The main screen appears as shown next:



To install the intended driver, just click on the corresponding icon on the left side and installation will start. The icons and drivers are described next:

Icon	Name	Description
	Chipset driver	Ensures the full function of the following drivers. Install this driver before installing the other device drivers.
	Video driver	Installs the video driver that allows you to select high-resolution displays with richer colors.
	Audio driver	Installs the audio driver that allows you to take full advantage of the audio subsystem.
	Modem driver	Installs the modem driver that allows you to use the modem function of the computer.
	LAN driver	Installs the LAN driver that allows you to use the network function of the computer.
	Card Reader driver	Allows you to use the Card Reader to access optional MMC/SD/MS cards.
	Touchpad driver	Installs the touchpad driver that allows you to take full advantage of the touchpad features.
	WLAN driver (option)	Installs the WLAN driver that allows you to use the computer's internal Mini-PCI Type-IIIB WLAN card's network function. NOTE: The Windows Plug-and-Play capability may automatically detect the new device (Mini-PCI WLAN card) and display the wizard requesting for drivers. Click Cancel to bypass the wizard screen(s).
	Adobe Acrobat Reader	Installs the Adobe Acrobat Reader program if you do not have it on your computer. You need Adobe Acrobat Reader to open the manual files supplied on this driver CD.
	User's Manuals	Allows you to select the manual in a particular language to view.





Icon	Name	Description
	On Screen Display (OSD) utility	Installs the OSD utility that provides a graphic display to indicate the current status of certain operations (see “Using the OSD Utility” section for details). NOTE: This OSD utility is an option for you. You can decide whether you would like to have this utility installed.
	Browse CD	Browses the contents of this CD.

Using the OSD

NOTE: The OSD utility is an option for you. You can decide whether you would like to have this utility installed.

With the OSD utility installed, the utility will be activated and the icon  will appear on the system tray every time Windows starts up.

A graphic display will appear on the screen for only a few seconds to indicate the current status of certain operations (as listed next).

Hot Key/Button Operation	OSD Description
Fn+F1 / 	Icon and text appear on the screen to indicate that wireless LAN is on or off.
Fn+F3 / Fn+F4 /  / 	A bar appears on the screen whenever you press the hot keys or volume control keys, as well as adjust Windows or any of its application program's volume control (e.g., Windows Media Player, etc.) to indicate the volume level.
Fn+F5	Icon and text appear on the screen to indicate the current display output.
Fn+F6 Fn+F7	A bar appears on the screen to indicate the brightness level.
	The icon  appears on the screen when you press the mute key to indicate that system sound output is off (mute).
AC in/out	Icon and text appear on the screen to indicate that AC power cord has been connected or unplugged.

Changing the OSD Color

You can change the colors of the individual OSD elements. Right-click on the OSD utility icon  on Windows system tray. Click on **Color** and the following window appears.

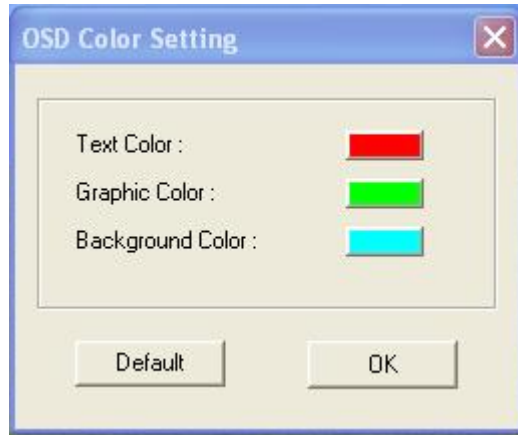

To change the color of an element such as text, graphic, and background, click on the corresponding color square and the next window appears where you can specify the color.

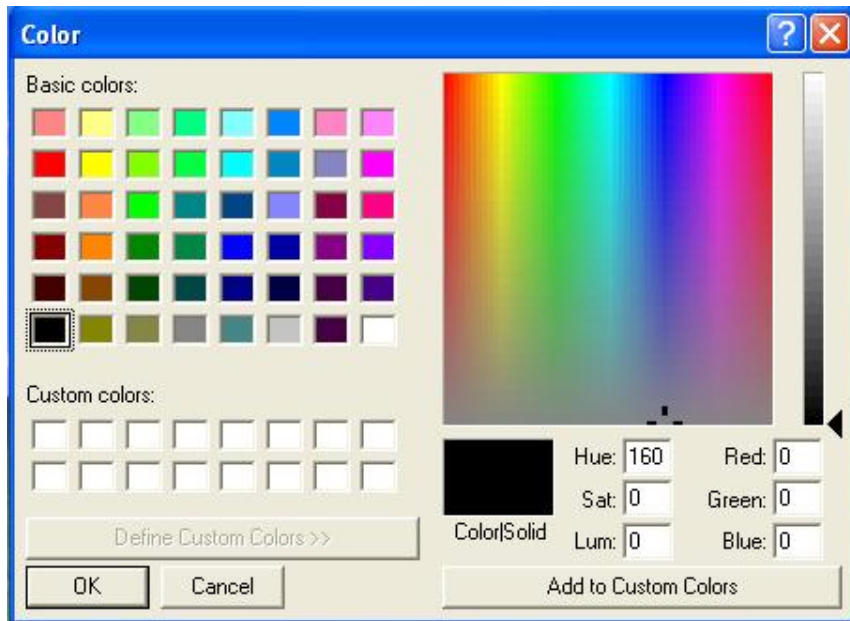

Windows would retain the settings the next time you restart the system.

Exiting and Reactivating the OSD Utility

To exit the OSD utility, right-click on the OSD utility icon  on Windows system tray and click on “Exit.”

Reactivate the OSD utility by any one of these methods:

- Double-click on the file `OSD.EXE` located on `c:/Program Files/OSD/` or
- Restart the system.

Caring for the Computer

Taking good care of your computer will ensure a trouble-free operation and reduce the risk of damage to your computer.

This chapter gives you guidelines covering these areas of maintenance:

- How to protect the computer
- What to note when using and storing the computer
- How to clean the computer
- What to note when using the battery pack
- What to note when traveling with the computer

Protecting the Computer

To safeguard the integrity of your computer data as well as the computer itself, you can protect the computer in several ways as described in this section.

Using the Password

The power-on password protects your computer against unauthorized use. If the password is set, the prompt requesting for the password appears on the screen whenever the computer is turned on.

The password is set via the BIOS Setup program. See “Security Menu” in Chapter 5 for instructions.

Using the Cable Lock

You can use a Kensington-type cable lock to protect your computer against theft. The cable lock is available in most computer stores.

To use the lock, loop the lock cable around a stationary object such as a table. Insert the lock to the Kensington lock hole and turn the key to secure the lock. Store the key in a safe place.

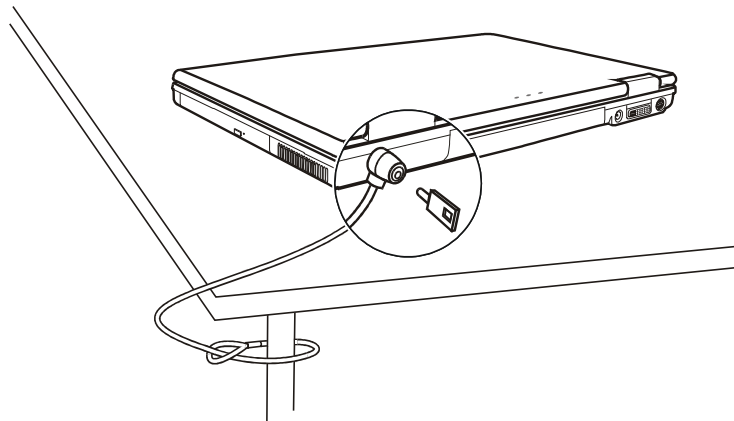

Using an Anti-Virus Strategy

New viruses are always being developed nowadays and they are attacking computers even more easily with emails so commonly used worldwide.

You can install a virus-detecting program to monitor potential viruses that could damage your files.

Taking Care of the Computer

Location Guidelines

- Use the computer where the temperature is between 10 °C (50 °F) and 35 °C (95 °F).
- Avoid placing the computer in a location subject to high humidity, extreme temperatures, mechanical vibration, direct sunlight, or heavy dust.
- Do not cover or block any ventilation openings on the computer. For example, do not place the computer on a bed, sofa, rug, or other similar surface. Otherwise, overheating may occur that results in damage to the computer.
- Keep the computer at least 13 cm (5 inches) away from electrical appliances that can generate a strong magnetic field such as a TV, refrigerator, motor, or a large audio speaker.
- Do not move the computer abruptly from a cold to a warm place. A temperature difference of more than 10 °C (18 °F) will cause condensation inside the unit, which may damage the storage media.
- Do not place the computer on an unsteady surface.

General Guidelines

- Do not place heavy objects on top of the computer when it is closed as this may damage the display.
- The screen surface is easily scratched. Do not use paper towels to clean the display. Avoid touching it with your fingers, pen, or pencil.
- To maximize the life of the backlight in the display, allow the backlight to automatically turn off as a result of power management. Avoid using a screen saver or other software that prevents the power management from working.

Cleaning Guidelines

- Never clean the computer with its power on.
- Use a soft cloth moistened with water or a non-alkaline detergent to wipe the exterior of the computer.
- Gently wipe the display with a soft, lint-free cloth. Do not use alcohol or detergent on the display.
- Dust or grease on the touchpad can affect its sensitivity. Clean the pad by using adhesive tape to remove the dust and grease on its surface.

Battery Pack Guidelines

- Recharge the battery pack when it is nearly discharged. When recharging, make sure that the battery pack is fully charged. Doing so may avoid harm to the battery pack.
- Operate the computer with the battery pack installed even when using external power. This ensures that the battery is fully charged.
- Do not leave the battery pack in storage for more than 6 months without recharging it.

When Traveling

- Before traveling with your computer, make a backup of your hard disk data into USB disks or other storage devices. As an added precaution, bring along an extra copy of your important data.
- Make sure that the battery pack is fully charged.
- Make sure that the computer is turned off and the top cover is securely closed.
- Do not leave objects in between the keyboard and closed display.
- Disconnect the AC adapter from the computer and take it with you. Use the AC adapter as the power source and as a battery-charger.
- Hand-carry the computer. Do not check it in as luggage.
- If you need to leave the computer in the car, place it in the trunk of the car to avoid exposing the computer to excessive heat.
- When going through airport security, it is recommended that you send the computer and USB disk through the X-ray machine (the device you set your bags on). Avoid the magnetic detector (the device you walk through) or the magnetic wand (the handheld device used by security personnel).
- If you plan to travel abroad with your computer, consult your dealer for the appropriate AC power cord for use in your country of destination.

Troubleshooting

Computer problems can be caused by hardware, software, or both. When you encounter any problem, it might be a typical problem that can easily be solved.

This chapter tells you what actions to take when solving common computer problems. It is divided into three sections:

- Preliminary checklist
- Solving common problems
- Resetting the computer

Preliminary Checklist

Here are helpful hints to follow before you take further actions when you encounter any problem:

- Try to isolate which part of the computer is causing the problem.
- Make sure that you turn on all peripheral devices before turning on the computer.
- If an external device has a problem, make sure that the cable connections are correct and secure.
- Make sure that the configuration information is properly set in the BIOS Setup program.
- Make sure that all the device drivers are correctly installed.
- Make notes of your observations. Are there any messages on the screen? Do any indicators light? Do you hear any beeps? Detailed descriptions are useful to the service personnel when you need to consult one for assistance.

If any problem persists after you follow the instructions in this chapter, contact an authorized dealer for help.

Solving Common Problems

For easy reference, the problems are divided into these categories.

Problem Type	Go to
Battery Problems	P. 4
DVD Drive Problems	P. 4
Display Problems	P. 5
Hardware Device Problems	P. 8
Hard Disk Drive Problems	P. 8
Keyboard, Mouse, and Touchpad Problems	P. 8
LAN Problems	P. 9
WLAN Problems	P. 9
Modem Problems	P. 9
PC Card Problems	P. 11
Power Management Problems	P. 12
Software Problems	P. 12
Sound Problems	P. 13
Startup Problems	P. 14
Other Problems	P. 14

Battery Problems

The battery does not charge (Battery Charge indicator does not light amber).

- Make sure that the AC adapter is properly connected.
- Make sure that the battery is not too hot or cold. Allow time for the battery pack to return to room temperature.
- Make sure that the battery pack is installed correctly.
- Make sure that the battery terminals are clean.

The operating time of a fully charged battery becomes shorter.

- If you often partially recharge and discharge, the battery might not be charged to its full potential. Initialize the battery to solve the problem (see “Initializing the Battery Pack” in Chapter 3 for instructions).

The battery operating time indicated by the battery meter does not match the actual operating time.

- The actual operating time can be different from the estimated time, depending on how you are using the computer. If the actual operating time is much less than the estimated time, initialize the battery (see “Initializing the Battery Pack” in Chapter 3 for instructions).

DVD Drive Problems

The DVD drive cannot read a disc.

- Make sure that the disc is correctly seated in the tray.
- Make sure that the disc is not dirty. Clean the disc with a disc cleaning kit, available in most computer stores.
- Make sure that the computer supports the disc or the files contained.

You cannot eject a disc.

- The disc is not properly seated in the drive. Manually release the disc following the method described next:
 1. Turn off the system.
 2. Insert a small rod, such as a straightened paperclip, into the drive's manual eject hole and push firmly to release the tray.
 3. Pull the tray out until fully extended, and then remove the disc.

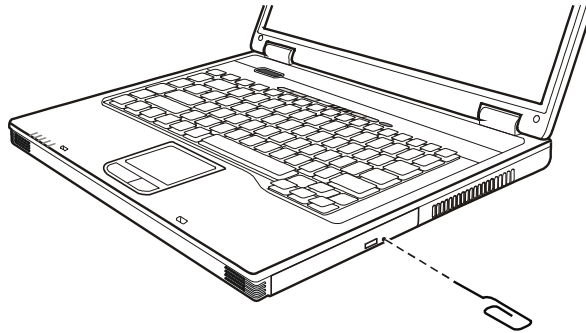

Display Problems

Nothing appears on the screen.

- During operation, the screen may automatically turn off as a result of power management. Press any key to see if the screen comes back.
- The brightness level might be too low. Increase brightness by pressing **Fn+F7**.
- The display output might be set to an external device. To switch the display back to the LCD, press **Fn+F5**, or change the display through the settings in **Display Properties**.

The characters on the screen are dim.

- Adjust the brightness and/or contrast.

Bad dots appear on the display at all times.

- A small number of missing, discolored, or bright dots on the screen are an intrinsic characteristic of TFT LCD technology. It is not regarded as a LCD defect.

Term definition:

Bright dots When the LCD screen is lighted, dots appear bright at a dark area. Red/green/blue bright dots also count.

Dark dots When the LCD screen is lighted, dots appear black at bright areas.

Distance between defective dots The minimum distance between two defective dots.

Adjacent defective dots Defective dots within a radius of 10 mm.

LCD Type	Defective dots		Distance between defective dots		Two adjacent defective dots		Three or more adjacent defective dots		Total
	Bright	Dark	Bright	Dark	Bright	Dark	Bright	Dark	
14.1" XGA	N≤5	N≤7	≤15mm	≤15mm	≤2 Pairs	≤2 Pairs	Not allowed	Not allowed	N≤9
15" XGA	N≤8	N≤8	≤15mm	≤15mm	≤2 Pairs	≤2 Pairs	Not allowed	Not allowed	N≤10
18" XGA	N≤9	N≤15	≤5mm	≤20mm	≤3 Pairs	≤5 Pairs	Not allowed	Not allowed	N≤20

Resolution cannot be adjusted to desired setting.

- Make sure that the video driver is installed correctly.

The external monitor displays nothing.

- Make sure that the monitor is turned on.
- Make sure that the monitor's signal cable is properly connected.
- Switch the display to the monitor by pressing **Fn+F5**, or change the display through the settings in **Display Properties**.

Simultaneous display/multi-display does not work.

- Make sure that you turn on the external monitor before turning on the computer.
- Press **Fn+F5** to toggle through the display options or change the settings in **Display Properties** in Windows.

Hardware Device Problems

The computer does not recognize a newly installed device.

- The device may not be correctly configured in the SCU program. Run the SCU program to identify the new type.
- Make sure if any device driver needs to be installed (refer to the documentation that came with the device).
- Make sure if the device needs any jumper or switch settings (refer to the documentation that came with the device).
- Check the cables or power cords for correct connections.
- For an external device that has its own power switch, make sure that the power is turned on.

Hard Disk Drive Problems

The hard disk drive error message appears on the screen.

- The hard disk drive has defects. Ask your dealer for help.

The hard disk drive operations seem slow.

- The data files stored on the hard disk drive may be fragmented. Use a tool such as Window's **Disk Defragmenter** to defragment the files.

The hard disk drive in-use indicator glows without blinking.

- The data files stored on the hard disk drive may be fragmented. Use a tool such as Window's **Disk Defragmenter** to defragment the files.

Keyboard, Mouse, and Touchpad Problems

The keyboard does not respond.

- Try connecting an external keyboard. If it works, contact an authorized dealer, as the internal keyboard cable might be loose.

The numeric keypad is disabled.

- Make sure that the **Num Lock** is switched on (check if the Num Lock Indicator  glows or not).

The external keyboard does not work.

- Make sure that the keyboard cable is properly connected.

The USB mouse does not work.

- Make sure that the mouse cable is properly connected.

The touchpad does not work, or the pointer is difficult to control with the touchpad.

- Make sure that the touchpad driver is correctly installed.
- Make sure that the touchpad is clean.

LAN Problems

I cannot access the network.

- Make sure that the LAN driver is correctly installed.
- Make sure that the LAN cable is properly connected to the RJ-45 connector and the network hub.
- Make sure that the network configuration is appropriate.
- Make sure that the user name or password is correct.

WLAN Problems

I cannot use the WLAN feature.

- Make sure that the Mini PCI WLAN card is correctly installed.
- Make sure that the necessary driver(s) is correctly installed.
- Make sure that the WLAN feature is turned on.

Transmission quality is poor.

- Your computer may be in an out-of-range situation. Move your computer closer to the Access Point or another WLAN device it is associated with.
- Check if there is high interference around the environment and solve the problem as described next.

Radio interference exists.

- Move your computer away from the device causing the radio interference such as microwave oven and large metal objects.
- Plug your computer into an outlet on a different branch circuit from that used by the affecting device.
- Consult your dealer or an experienced radio technician for help.

I cannot connect to another WLAN device.

- Make sure that the WLAN feature is turned on.
- Make sure that the SSID setting is the same for every WLAN device in the network.
- Your computer is not recognizing changes. Restart the computer.
- Make sure that the IP address or subnet mask setting is correct.

I cannot communicate with the computer in the network when Infrastructure mode is configured.

- Make sure that the Access Point your computer is associated with is powered on and all the LEDs are working properly.
- If the operating radio channel is in poor quality, change the Access Point and all the wireless station(s) within the BSSID to another radio channel.
- Your computer may be in an out-of-range situation. Move your computer closer to the Access Point it is associated with.
- Make sure that your computer is configured with the same security option (encryption) to the Access Point.

- Use the Web Manager/Telnet of the Access Point to check whether it is connected to the network.
- Reconfigure and reset the Access Point.

I cannot access the network.

- Make sure that the necessary driver(s) is correctly installed.
- Make sure that the network configuration is appropriate.
- Make sure that the user name or password is correct.
- You have moved out of range of the network.
- Turn off power management.

Modem Problems

The modem does not work.

- Make sure that the modem driver is correctly installed.
- Make sure that the telephone line is properly connected.
- Make sure that the COM port in the communication software is correctly set.
- Turn off power management.

PC Card Problems

The PC card does not work.

- Make sure that the PC card is correctly seated.
- If the card requires an IRQ (Interrupt ReQuest), make sure that there is one available.

The PC card stops communicating properly.

- The application may have been reset when the computer is turned off or in Standby mode. Exit and restart the application.

Power Management Problems

The computer does not enter Standby or Hibernation mode automatically.

- If you have a connection to another computer, the computer does not enter Standby or Hibernation mode if the connection is actively in use.
- Make sure that the Standby or Hibernation time-out is enabled.

The computer does not enter Standby or Hibernation mode immediately.

- If the computer is performing an operation, it normally waits for the operation to finish.

The computer does not resume from Standby or Hibernation mode.

- The computer automatically enters Standby or Hibernation mode when the battery pack is empty. Do any one of the following:
 - Connect the AC adapter to the computer.
 - Replace the empty battery pack with a fully charged one.

The computer does not enter Hibernation mode with the Fn+F12 hot keys.

- Make sure that the Hibernation function is specified for the sleep button.
- You might be using a PC card that prevents the computer from entering Hibernation mode. To enter the mode, stop the communication program and then remove the card or stop the card.

Software Problems

An application program does not work correctly.

- Make sure that the software is correctly installed.
- If an error message appears on the screen, consult the software program's documentation for further information.

- If you are sure the operation has stop, reset the computer (see “Resetting the Computer” later in this chapter).

Sound Problems

No sound is produced.

- Make sure that the volume control is not set too low.
- Make sure that the audio driver is correctly installed.
- Make sure that the computer is not in Standby mode.
- If using an external speaker, make sure that the speaker is properly connected.

Distorted sound is produced.

- Make sure that the volume control is not set too high or too low. In most cases, a high setting can cause the audio electronics to distort the sound.

The sound system does not record.

- Adjust the playback or recording sound levels.

The external microphone or audio device does not work.

- Make sure that the microphone is connected to the proper connector on the computer.
- Make sure that your computer is equipped with the driver needed.
- Click the speaker symbol on the taskbar and check the Windows volume control.
- Check the volume control of your computer.

Startup Problems

When you turn on the computer, it does not respond and the Power Indicator does not light green.

- If you are using an external AC power, make sure that the AC adapter is correctly and securely connected. If so, make sure that the electrical outlet works properly.
- If you are using the battery power, make sure that the battery is not discharged.

When you turn on the computer, it stops after POST.

- Restart your computer.

Other Problems

The date/time is incorrect.

- Correct the date and time via the operating system or SCU program.
- After you have performed everything as described above and still have the incorrect date and time every time you turn on the computer, the RTC (Real-Time Clock) battery is at the end of its life. Call an authorized dealer to replace the RTC battery.

Resetting the Computer

You may have to reset (reboot) your computer on some occasions when an error occurs and the program you are using hangs up.

If the system operation seems to hang up, first wait. It is possible that the system is processing data. Periodically check the hard disk drive in-use indicator, if it flashes irregularly, the program may be accessing data and preventing you from using the keyboard. If you are sure the operation has stopped and you cannot use the “restart” function of the operating system, reset the computer.

Reset the computer by any one of these methods:

- Press **Ctrl+Alt+Del**.
- If the above action does not work, turn off the system. Wait for at least five seconds and turn it on again.

| **CAUTION:** Resetting will cause any unsaved data to be lost.

Specifications

NOTE: Specifications are subject to change without any prior notice.

Parts		Specifications
CPU		Mobile Pentium-M Dothan processor, 400/533 FSB (Front Side Bus) thermal specifications 27 W
L2 Cache		1 MB on-die for Intel Celeron 2 MB on-die for Intel Pentium-M
ROM BIOS		512 KB Flash EEPROM (includes system BIOS), ACPI, Plug & Play capability
System RAM		2 × 200-pin DDRII SDRAM DIMM socket for expansion, supports DDRII 400/533 specifications
Display	Panel	15.4-inch TFT, resolution up to 1280×800 WXGA / 1680×1050 WSXGA+
	Video controller	NVIDIA NV43M
	Video ports	DVI-I port, S-video port (PAL/NTSC)
Audio ports		Mic-in, S/PDIF-out
Keyboard		Standard keys, numeric keypad, 12 function keys, a special Fn (Function) key and Windows keys
Pointing device		Touchpad with 2 buttons
Storage device	Hard disk drive	2.5-inch, 4200/5400 RPM, Ultra DMA Parallel ATA (PATA) interface
	Optical drive	Combo / DVD +RW / DVD -RW / DVD-Dual / Super Multi
PC card		Type II × 1, PCMCIA Standard Rev.2.1, CardBus support
Card Reader		3-in-1 (MMC/SD/MS card) module
I/O ports		Four USB ports (USB 2.0 support), IEEE 1394a port
Modem		Built-in 56 Kbps V.90 MDC internal fax modem, Azalia interface
LAN		Built-in 10/100Base-TX
Wireless LAN (option)		One Mini PCI slot and antenna reserved for wireless LAN card, IEEE 802.11b+g (pre-installed in selected models)

Parts		Specifications
Power	AC adapter	Universal AC adapter 90 W; input: 100~240 V, (supports power-on charge)
	Battery	6 cell, 2200 mAh Li-ion Smart battery 9 cell, 2200 mAh (option)
Dimension (W×D×H)		14×10.24×1.4 inch (354×260×35.5 mm)
Weight		6.4 lb (2.9 kg)
Environment	Temperature	Operating: 0 °C (32 °F) to 40 °C (104 °F) Storage: -20 °C (-4 °F) to 70 °C (158 °F)
	Humidity	Operating: 20% to 80% non-condensing Storage: 10% to 90% non-condensing

Regulatory Information

This appendix provides regulatory statements and safety notices on your computer.

NOTE: Marking labels located on the exterior of your computer indicate the regulations that your model complies with. Please check the marking labels and refer to the corresponding statements in this appendix. Some notices apply to specific models only.

On the Use of the System

Class B Regulations

USA

Federal Communications Commission Radio Frequency Interference Statement

NOTE:

This equipment has been tested and found to comply with the limits for a Class B digital device pursuant to Part 15 of the FCC Rules. These limits are designed to provide reasonable protection against harmful interference in a residential installation. This equipment generates, uses, and can radiate radio frequency energy and, if not installed and used in accordance with the instructions, may cause harmful interference to radio communications. However, there is no guarantee that interference will not occur in a particular installation. If this equipment does cause harmful interference to radio or television reception, which can be determined by turning the equipment off and on, the user is encouraged to try to correct the interference by one or more of the following measures:

- Reorient or relocate the receiving antenna.
- Increase the separation between the equipment and receiver.
- Connect the equipment into an outlet on a circuit different from that to which the receiver is connected.
- Consult the dealer or an experienced radio/TV technician for help.

Any changes or modifications not expressly approved by the manufacturer could void the user's authority to operate the equipment.

Please note:

The use of a non-shielded interface cable with this equipment is prohibited.

Canada

Canadian Department of Communications Radio Interference Regulations Class B Compliance Notice

This Class B digital apparatus meets all requirements of the Canada Interference-Causing equipment regulations.

Cet appareil numérique de Classe B respecte toutes les exigences du Règlement Canadien sur le matériel brouilleur.

This digital apparatus does not exceed the Class B limits for radio noise emissions from digital apparatus set out in the Radio Interference Regulations of the Canadian Department of Communications.

Le présent appareil numérique n'émet pas de bruits radioélectriques dépassant les limites applicables aux appareils numériques de la classe B prescrites dans le Règlement sur le brouillage radioélectrique édicté par le ministère des Communications du Canada.

Safety Notices

About the Battery

Caution Texts Concerning Lithium Batteries

DANISH

ADVARSEL! Lithiumbatteri – Eksplosionsfare ved fejlagtig håndtering. Udskiftning må kun ske med batteri af samme fabrikat og type. Levér det brugte batteri tilbage til leverandøren.

NORWEGIAN

ADVARSEL: Eksplosjonsfare ved feilaktig skifte av batteri. Benytt samme batteritype eller en tilsvarende type anbefalt av apparatfabrikanten. Brukte batterier kasseres i henhold til fabrikantens instruksjoner.

SWEDISH

VARNING: Explosionsfara vid felaktigt batteribyte. Använd samma batterityp eller en ekvivalent typ som rekommenderas av apparattillverkaren. Kassera använt batteri enligt fabrikantens instruktion.

FINNISH

VAROITUS: Paristo voi räjähtää, jos se on virheellisesti asennettu. Vaihda paristo ainoastaan valmistajan suositteluun tyyppiin. Hävitä käytetty paristo valmistajan ohjeiden mukaisesti.

ENGLISH

CAUTION: Danger of explosion if battery is incorrectly replaced. Replace only with the same or equivalent type recommended by the equipment manufacturer. Discard used batteries according to manufacturer's instructions.

DEUTSCH

VORSICHT: Explosionsgefahr bei unsachgemäßem Austausch der Batterie. Ersatz nur durch denselben oder einen vom Hersteller empfohlenen gleichwertigen Typ. Entsorgung gebrauchter Batterien nach Angaben des Herstellers.

FRENCH

ATTENTION: Il y a danger d'explosion s'il y a remplacement incorrect de la batterie. Remplacer uniquement avec une batterie du même type ou d'un type équivalent recommandé par le constructeur. Mettre au rebut les batteries usagées conformément aux instructions du fabricant.

Attention (for USA Users)

The product that you have purchased contains a rechargeable battery. The battery is recyclable. At the end of its useful life, under various state and local laws, it may be illegal to dispose of this battery into the municipal waste stream. Check with your local solid waste officials for details in your area for recycling options or proper disposal.

About the AC Adapter

- Use only the AC adapter supplied with your computer. Use of another type of AC adapter will result in malfunction and/or danger.
- Do not use the adapter in a high moisture environment. Never touch the adapter when your hands or feet are wet.
- Allow adequate ventilation around the adapter when using it to operate the device or charge the battery. Do not cover the AC adapter with paper or other objects that will reduce cooling. Do not use the AC adapter while it is inside a carrying case.
- Connect the adapter to a proper power source. The voltage requirements are found on the product case and/or packaging.
- Do not use the adapter if the cord becomes damaged.
- Do not attempt to service the unit. There are no serviceable parts inside. Replace the unit if it is damaged or exposed to excess moisture.

About the Modem

Caution

- Never install telephone wiring during a lightning storm.
- Never install telephone jacks in wet locations unless the jack is specifically designed for wet locations.
- Never touch non-insulated telephone wires or terminals unless the telephone line has been disconnected at the network interface.
- Use caution when installing or modifying telephone lines.
- Avoid using the telephone function (other than a cordless type) during an electrical storm. There may be a remote risk of electric shock from lightning.
- Do not use the telephone function to report a gas leak in the vicinity of the leak.
- Do not use this product near water, for example near a bathtub, wash bowl, kitchen sink or laundry tub, in a wet basement or near a swimming pool.

Caution (for USA Users)

To reduce the risk of fire, use only No.26 AWG or larger telecommunication line cord.

On the Use of RF Device

NOTE: The information in this section applies to models with the wireless LAN module.

USA and Canada Safety Requirements and Notices

IMPORTANT NOTE: To comply with FCC RF exposure compliance requirements, the antenna used for this transmitter must be installed to provide a separation distance of at least 20 cm from all persons and must not be co-located or operating in conjunction with any other antenna or transmitter.

Radio Frequency Interference Requirements and SAR

The FCC with its action in ET Docket 93-62 has adopted a safety standard for human exposure to Radio Frequency (RF) electromagnetic energy emitted by FCC certified equipment. The wireless LAN module meets the Human Exposure limits found in OET Bulletin 65, 2001, and ANSI/IEEE C95.1, 1992. Proper operation of this radio according to the instructions found in this manual will result in exposure substantially below the FCC's recommended limits. The following safety precautions should be observed:

- Do not touch or move antenna while the unit is transmitting or receiving.
- Do not hold any component containing the radio such that the antenna is very close or touching any exposed parts of the body, especially the face or eyes, while transmitting.
- Do not operate the radio or attempt to transmit data unless the antenna is connected; if not, the radio may be damaged.

Use in specific environments:

- The use of wireless devices in hazardous locations is limited by the constraints posed by the safety directors of such environments.
- The use of wireless devices on airplanes is governed by the Federal Aviation Administration (FAA).
- The use of wireless devices in hospitals is restricted to the limits set forth by each hospital.

Antenna use:

- In order to comply with FCC RF exposure limits, low gain integrated antennas should be located at a minimum distance of 20 cm (8 inches) or more from the body of all persons.
- High-gain, wall-mount, or mast-mount antennas are designed to be professionally installed and should be located at a minimum distance of 30 cm (12 inches) or more from the body of all persons. Please contact your professional installer, VAR, or antenna manufacturer for proper installation requirements.

Explosive Device Proximity Warning

WARNING: Do not operate a portable transmitter (such as a wireless network device) near unshielded blasting caps or in an explosive environment unless the device has been modified to be qualified for such use.

Antenna Warning

WARNING: To comply with the FCC and ANSI C95.1 RF exposure limits, it is recommended that the antenna for this device be installed so as to provide a separation distance of at least 20 cm (8 inches) from all persons and that the antenna must not be co-located or operating in conjunction with any other antenna or radio transmitter. It is recommended that the user limit exposure time if the antenna is positioned closer than 20 cm (8 inches).

Use on Aircraft Caution

CAUTION: Regulations of the FCC and FAA prohibit airborne operation of radio-frequency wireless devices because their signals could interfere with critical aircraft instruments.

EMC Requirements

This device uses, generates and radiates radio frequency energy. The radio frequency energy produced by this device is well below the maximum exposure allowed by the Federal Communications Commission (FCC).

This device complies with the limits for a Class B digital device pursuant to Part 15 subpart C of the FCC Rules and Regulations. Operation is subject to the following two conditions:

- (1) This device may not cause harmful interference.
- (2) This device must accept any interference received, including interference that may cause undesired operation.

The FCC limits are designed to provide reasonable protection against harmful interference when the equipment is installed and used in accordance with the instruction manual and operated in a commercial environment. However, there is no guarantee that interference will not occur in a particular commercial installation, or if operated in a residential area.

If harmful interference with radio or television reception occurs when the device is turned on, the user must correct the situation at the user's own expense. The user is encouraged to try one or more of the following corrective measures:

- Reorient or relocate the receiving antenna.
- Increase the separation between the equipment and receiver.
- Connect the equipment into an outlet on a circuit different from that to which the receiver is connected.
- Consult the dealer or an experienced radio/TV technician for help.

CAUTION: The Part 15 radio device operates on a non-interference basis with other devices operating at this frequency. Any changes or modification to said product not expressly approved by the manufacturer could void the user's authority to operate this device.

Canada Radio Frequency Interference Requirements

To prevent radio interference to the licensed service, this device is intended to be operated indoors and away from windows to provide maximum shielding. Equipment (or its transmit antenna) that is installed outdoors is subject to licensing.

Pour empêcher que cet appareil cause du brouillage au service faisant l'objet d'une licence, il doit être utilisé à l'intérieur et devrait être placé loin des fenêtres afin de fournir un écran de blindage maximal. Si le matériel (ou son antenne d'émission) est installé à l'extérieur, il doit faire l'objet d'une licence.

European Union CE Marking and Compliance Notices

Statements of Compliance

English

This product follows the provisions of the European Directive 1999/5/EC.

Danish

Dette produkt er i overensstemmelse med det europæiske direktiv 1999/5/EC.

Dutch

Dit product is in navolging van de bepalingen van Europees Directief 1999/5/EC.

Finnish

Tämä tuote noudattaa EU-direktiivin 1999/5/EC määräyksiä.

French

Ce produit est conforme aux exigences de la Directive Européenne 1999/5/EC.

German

Dieses Produkt entspricht den Bestimmungen der Europäischen Richtlinie 1999/5/EC.

Greek

Το προϊόν αυτό πληροί τις προβλέψεις της Ευρωπαϊκής Οδηγίας 1999/5/EC.

Icelandic

Þessi vara stenst reglugerð Evrópska Efnahags Bandalagsins númer 1999/5/EC.

Italian

Questo prodotto è conforme alla Direttiva Europea 1999/5/EC.

Norwegian

Dette produktet er i henhold til bestemmelsene i det europeiske direktivet 1999/5/EC.

Portuguese

Este produto cumpre com as normas da Diretiva Europeia 1999/5/EC.

Spanish

Este producto cumple con las normas del Directivo Europeo 1999/5/EC.

Swedish

Denna produkt har tillverkats i enlighet med EG-direktiv 1999/5/EC.

Local Restrictions of 802.11g Radio Usage

CAUTION: Due to the fact that the frequencies used by 802.11g wireless LAN devices may not yet be harmonized in all countries, 802.11g products are designed for use only in specific countries or regions, and was not allowed to be operated in countries or regions other than those of designated use. As a user of these products, you are responsible for ensuring that the products are used only in the countries or regions for which they were intended and for verifying that they are configured with the correct selection of frequency and channel for the country or region of use. Any deviation from permissible settings and restrictions in the country or region of use could be an infringement of local law and may be punished as such.

The European variant is intended for use throughout the European Economic Area. However, authorization for use is further restricted in particular countries or regions within countries, as follows:

General

European standards dictate maximum radiated transmit power of 100 mW Effective Isotropic Radiated Power (EIRP) and the frequency range 2400 – 2483.5 MHz.

Belgium and the Netherlands

In Belgium and the Netherlands, the product may not be used outdoors. See the instructions next under the heading “How to Turn Off the Wireless LAN Radio.”

France

Departments in Which the Wireless LAN Module Can Be Used (Indoors Only)

The wireless LAN module can currently be used indoors only in the following 38 departments of mainland France. Please turn off your wireless LAN radio when operating the device in areas/places other than the 38 departments listed:

01	Ain Orientales	36	Indre	66	Pyrénées
02	Aisne	37	Indre et Loire	67	Bas Rhin
03	Allier	41	Loir et Cher	68	Haut Rhin
05	Hautes Alpes	42	Loire	70	Haute Saône
08	Ardennes	45	Loiret	71	Saône et Loire
09	Ariège	50	Manche	75	Paris
11	Aude	55	Meuse	82	Tarn et Garonne
12	Aveyron	58	Nièvre	84	Vaucluse
16	Charente	59	Nord	88	Vosges
24	Dordogne	60	Oise	89	Yonne
25	Doubs	61	Orne	90	Territoire de Belfort
26	Drôme	63	Puy du Dôme	94	Val de Marne
32	Gers	64	Pyrénées Atlantique		

Departments in Which the Wireless LAN Module's Maximum EIRP Not Shown in the Previous Table

Frequency Ranges (MHz)	Indoors	Outdoors
2400 – 2446.5	10 mW	Not permitted
2446.5 – 2483.5	100 mW	100 mW on private property with Ministry of Defense approval

Turning Off the Wireless LAN Radio

NOTE: Turning the wireless LAN radio off is not the same as disabling the wireless LAN card. It is not necessary to disable the card to meet the regulatory requirements.

While operating the computer in those French departments that do not allow use of the wireless LAN equipment, the user of the equipment must turn off the wireless LAN radio in order to comply with local regulations (see chapter 2 for more information).

Index

1		BIOS Setup	1
1394 cable	6	Boot menu	6
1394a port	6	Exit menu	7
A		Main menu	4
AC	2	Security menu	5
AC adapter	2	Starting	2
AC adapter		Boot device	6
Connecting	3	Bootling	2
AC power		Brightness	9
Connecting	2	Indicator	5
OSD	5	C	
ACPI	8	Caps Lock	5
Adobe Acrobat Reader	3	Caps Lock	
Alt key	4	Indicator	12
Anti-Virus	3	Card reader	
Audio driver	3	Indicator	11
Audio subsystem		Card Reader	7, 9
Connecting external devices	19	Driver installation	3
Features	18	Inserting a card	10
Volume control	11	CardBus	7
B		CD	6
Backspace key	4	Charging	3
Battery charge		Chipset driver	3
Indicator	3, 11	Class 1 laser product	15
Battery low		Cleaning the computer	5
Beep sound	9	Click	11
Battery pack	2, 3, 9	Combo drive	6, 14
Battery pack		Connecting external devices	
Charging	3	TV	4
Checking battery level	4	Connector	
Initializing	4	DVI	8
Replacing	5	Microphone	7
Taking care	5	Power	8
Battery low	6	S-video	8
		S/PDIF	7

O		Scroll	11
Operating system	2, 4	Scroll Lock	5
Optical drive	1	Scroll Lock Indicator	12
OSD utility	4	Secure Digital Security	7
Colors	5	Protecting the computer with lock	2
Turning off/on	7	Protecting the computer with password	2
Using	5	Shift key	4
P		Shutting down	3, 5
Password	5	Simultaneous display	17
Pause key	5	Sleep button	9
PC card	1, 7	Software driver	1
PC card		Speaker	11, 18
Inserting	7	Connecting external speakers	19
Removing	8	Specifications	1
slot	7	Standby	3, 8
PCMCIA	7	Startup	2
Point	11	Storage card	9
Pointing device	1	Inserting	10
POST	4	Removing	10
Power	2	Super Multi drive	14
Power		T	
Indicator	11	Telephone line	
Power button	2, 12	Connecting	20
Power connector	8	Connector	7
Power Management	8	Temperature	2
Power-On Self Test	4	TFT	17
Print Screen key	5	Time	4, 14
Q		Touchpad	1, 10, 11
Quick start key	10	Touchpad	
R		Configuring	12
RAM	1	Driver installation	3
Rebooting	15	Traveling with the computer	6
Regulatory Information	1	Troubleshooting	1
Resetting	15	Battery problem	4
Restarting	15	Display problem	5
RJ-11	7, 20	DVD drive problem	4
RJ-45	7, 21	Hard disk drive problem	8
ROM BIOS	1	Hardware problem	8
S		Keyboard problem	8
S-video cable	4	LAN problem	9
S-video connector	4, 8	Modem problem	11
S/PDIF connector	7, 19	Other problems	14
Saving power	10	PC card problem	11
Screen	10	Power Management problem	12

Software problem	12	Video controller	1
Sound problem	13	Virus	3
Startup problem	14	Volume	8, 11
WLAN problem	9	Indicator	5
Turning off	3, 5	W	
Turning on	4	Weight of the computer	2
Typewriter key	4	Windows	4
U		Windows key	7
Upgrading the computer	11	WLAN	1
USB device		WLAN	
Connecting	5	Configuring	22
USB port	5, 7	Driver installation	3
V		Hotkeys	8
Video driver	3	Indicator	5, 11
Video subsystem		Turning on	10, 22
Features	17	Using	21